

Stock & MTO Screw Conveyor Components



Screw Conveyor Components and Accessories



ANGLE FLANGED "U" TROUGH

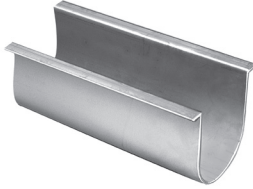

FORMED FLANGED "U" TROUGH

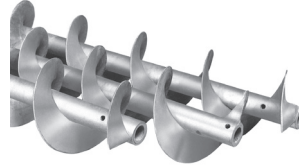

SECTIONAL SCREWS



SPECIAL SCREWS



TUBULAR HOUSING

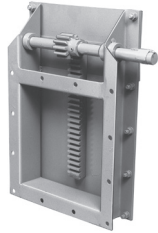

FLAT RACK AND PINION DISCHARGE GATE



TROUGH ENDS WITH AND WITHOUT FEET



SECTIONAL FLIGHTS



COUPLING SHAFTS



ELEVATOR BUCKETS

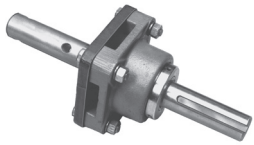

THRUST ASSEMBLY TYPE E WITH DRIVE SHAFT

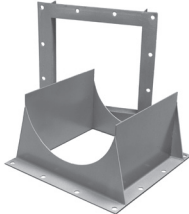

INLET AND DISCHARGE SPOUTS



SPLIT GLAND



HANGER STYLE 220



HANGER STYLE 226



HANGER STYLE 216



HANGER STYLE 70



HANGER STYLE 19B



TROUGH END BEARING BALL AND ROLLER

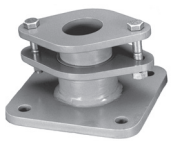

PACKING GLAND SHAFT SEAL COMPRESSION TYPE

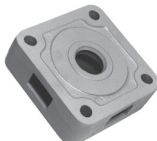

WASTE PACK SHAFT SEAL



PLATE SHAFT SEAL



DROP-OUT SHAFT SEAL FLANGED PRODUCT



HANGER BEARINGS STYLE 220/226

Martin HARD IRON
Martin BRONZE
NYLATRON
WHITE NYLON
WOOD
CERAMIC

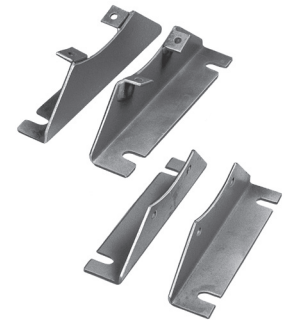

SADDLES AND FEET

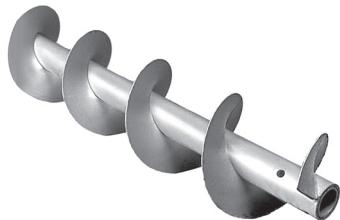

HELICOID SCREWS



HELICOID FLIGHTING RIGHT HAND AND LEFT HAND

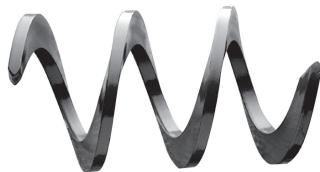

SHAFTLESS SCREWS

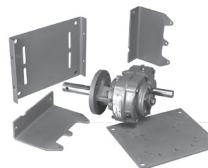

SCREW CONVEYOR DRIVE WITH ACCESSORIES

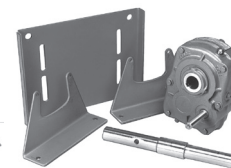

SPEED REDUCER SHAFT MOUNTED WITH ACCESSORIES



FLANGED COVER WITH ACCESSORIES

Martin manufactures the most complete line of stock components in the industry. We stock mild steel, stainless, galvanized, and many other items that are "special order" from the others in the industry.

ENGINEERING	PAGE
INTRODUCTION TO ENGINEERING SECTION	H-3
SCREW CONVEYOR DESIGN PROCEDURE	H-4
MATERIAL CLASSIFICATION CODE CHART	H-5
MATERIAL CHARACTERISTICS TABLES	H-6
SELECTION OF CONVEYOR SIZE AND SPEED	H-16
CAPACITY FACTOR TABLES	H-17
CAPACITY TABLE	H-18
LUMP SIZE LIMITATIONS AND TABLE	H-19
COMPONENT GROUP SELECTION	H-20
HANGER BEARING SELECTION	H-22
HORSEPOWER CALCULATION	H-23
TORSIONAL RATINGS OF CONVEYOR COMPONENTS	H-26
HORSEPOWER RATINGS OF CONVEYOR COMPONENTS	H-27
SCREW CONVEYOR END THRUST AND THERMAL EXPANSION	H-28
SCREW CONVEYOR DEFLECTION	H-29
INCLINED AND VERTICAL SCREW CONVEYORS	H-31
SCREW FEEDERS	H-32
APPENDIX GENERAL ENGINEERING INFORMATION	i-1

Introduction

The following section is designed to present the necessary engineering information to properly design and layout most conveyor applications. The information has been compiled from many years of experience in successful design and application and from industry standards.

We hope that the information presented will be helpful to you in determining the type and size of screw conveyor that will best suit your needs.

The “Screw Conveyor Design Procedure” on the following page gives ten step-by-step instructions for properly designing a screw conveyor. These steps, plus the many following tables and formulas throughout the engineering section will enable you to design and detail screw conveyor for most applications.

If your requirements present any complications not covered in this section, we invite you to contact our Engineering Department for recommendations and suggestions.

Screw Conveyor Design Procedure

STEP 1	Establish Known Factors	<ol style="list-style-type: none"> 1. Type of material to be conveyed. 2. Maximum size of hard lumps. 3. Percentage of hard lumps by volume. 4. Capacity required, in cu.ft./hr. 5. Capacity required, in lbs./hr. 6. Distance material to be conveyed. 7. Any additional factors that may affect conveyor or operations.
STEP 2	Classify Material	Classify the material according to the system shown in Table 1-1. Or, if the material is included in Table 1-2, use the classification shown in Table 1-2.
STEP 3	Determine Design Capacity	Determine design capacity as described on pages H-16–H-18.
STEP 4	Determine Diameter and Speed	Using known capacity required in cu.ft./hr., material classification, and % trough loading (Table 1-2) determine diameter and speed from Table 1-6.
STEP 5	Check Minimum Screw Diameter for Lump Size Limitations	Using known screw diameter and percentage of hard lumps, check minimum screw diameter from Table 1-7.
STEP 6	Determine Type of Bearings	From Table 1-2, determine hanger bearing group for the material to be conveyed. Locate this bearing group in Table 1-11 for the type of bearing recommended.
STEP 7	Determine Horsepower	From Table 1-2, determine Horsepower Factor "Fm" for the material to be conveyed. Refer to page H-23 and calculate horsepower by the formula method.
STEP 8	Check Torsional and/or Horsepower ratings of Standard Conveyor Components	Using required horsepower from step 7 refer to pages H-26 and H-27 to check capacities of standard conveyor pipe, shafts and coupling bolts.
STEP 9	Select Components	Select basic components from Tables 1-8, 1-9, and 1-10 in accordance with Component Group listed in Table 1-2 for the material to be conveyed. Select balance of components from the Components Section of catalog.
STEP 10	Conveyor Layouts	Refer to pages H-39 and H-40 for typical layout details.



Table 1-1 Material Classification Code Chart

Major Class	Material Characteristics Included		Code Designation
Density	Bulk Density, Loose		Actual lbs/PC
Size	Very Fine	No. 200 Sieve (.0029") and Under	A200
		No. 100 Sieve (.0059") and Under	A100
		No. 40 Sieve (.016") and Under	A40
	Fine	No. 6 Sieve (.132") and Under	B6
	Granular	1/2" And Under (6" Sieve to 1/2")	C1/2
		3" And Under (1/2" to 3")	D3
		7" And Under (3" to 7")	D7
	Lumpy	16" And Under (0" to 16")	D16
Over 16" To Be Specified, X = Actual Maximum Size		DX	
Irregular	Irregular Stringy, Fibrous, Cylindrical, Slabs, Etc.	E	
Flowability	Very Free Flowing		1
	Free Flowing		2
	Average Flowability		3
	Sluggish		4
Abrasiveness	Mildly Abrasive		5
	Moderately Abrasive		6
	Extremely Abrasive		7
Miscellaneous Properties or Hazards	Builds Up and Hardens		F
	Generates Static Electricity		G
	Decomposes — Deteriorates in Storage		H
	Flammability		J
	Becomes Plastic or Tends to Soften		K
	Very Dusty		L
	Aerates and Becomes a Fluid		M
	Explosiveness		N
	Stickiness — Adhesion		O
	Contaminable, Affecting Use		P
	Degradable, Affecting Use		Q
	Gives Off Harmful or Toxic Gas or Fumes		R
	Highly Corrosive		S
	Mildly Corrosive		T
	Hygroscopic		U
	Interlocks, Mats or Agglomerates		V
	Oils Present		W
	Packs Under Pressure		X
	Very Light and Fluffy — May Be Windswept		Y
Elevated Temperature		Z	

Table 1-2 Material Characteristics



Material Characteristics

The material characteristics table (page H-7 or H-15) lists the following Design Data for many materials.

- A. The weight per cubic foot data may be used to calculate the required capacity of the conveyor in cubic feet per hour.
- B. B. The material code for each material is as described in Table 1-1, and as interpreted below.
- C. The Intermediate Bearing Selection Code is used to properly select the intermediate hanger bearing from Table 1-11 (Page H-22).
- D. The Component Series Code is used to determine the correct components to be used as shown on page H-21.
- E. The Material Factor Fm is used in determining horsepower as described on pages H-23 thru H-25.
- F. The Trough Loading column indicates the proper percent of cross section loading to use in determining diameter and speed of the conveyor.

For screw conveyor design purposes, conveyed materials are classified in accordance with the code system in Table 1-1, and listed in Table 1-2.

Table 1-2 lists many materials that can be effectively conveyed by a screw conveyor. If a material is not listed in Table 1-2, it must be classified according to Table 1-1 or by referring to a listed material similar in weight, particle size and other characteristics.

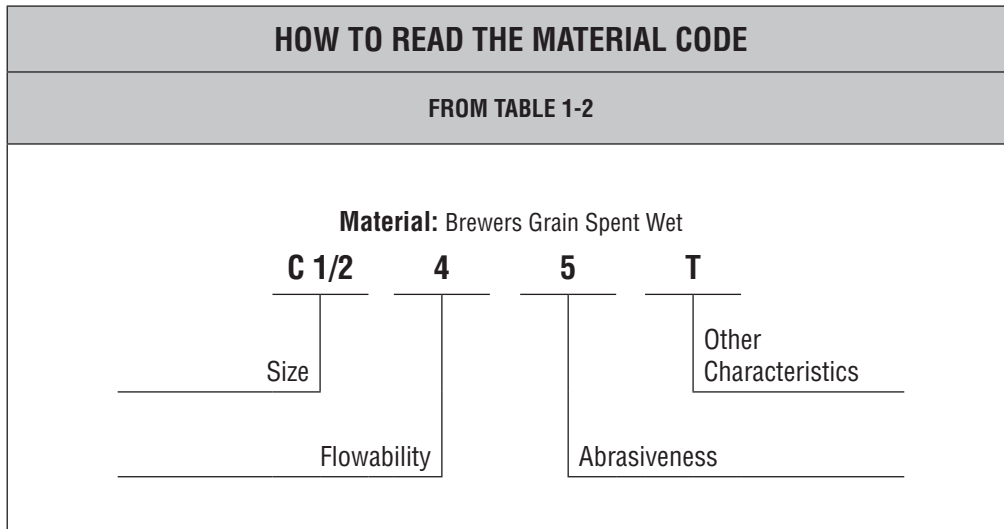

Material	Weight lbs. per cu. ft	Intermediate Material Code	Bearing Selection	Component Series	Material Factor Fm	Trough Loading
Adipic Acid	45	A100-35	S	2	.5	30A
Alfalfa Meal	14-22	B6-45WY	H	2	.6	30A
Alfalfa Pellets	41-43	C1/2-25	H	2	.5	45
Alfalfa Seed	10-15	B6-15N	L-S-B	1	.4	45
Almonds, Broken	27-30	C1/2-35Q	H	2	.9	30A
Almonds, Whole Shelled	28-30	C1/2-35Q	H	2	.9	30A
Alum, Fine	45-50	B6-35U	L-S-B	1	.6	30A
Alum, Lumpy	50-60	B6-25	L-S	2	1.4	45
Alumina	55-65	B6-27MY	H	3	1.8	15
Alumina, Fine	35	A100-27MY	H	3	1.6	15
Alumina Sized or Briquette	65	D3-37	H	3	2.0	15
Aluminate Gel (Aluminate Hydroxide)	45	B6-35	H	2	1.7	30A
Aluminum Chips, Dry	7-15	E-45V	H	2	1.2	30A
Aluminum Chips, Oily	7-15	E-45V	H	2	.8	30A
Aluminum Hydrate	13-20	C1/2-35	L-S-B	1	1.4	30A
Aluminum Ore (See Bauxite)	—	—	—	—	—	—
Aluminum Oxide	60-120	A100-17M	H	3	1.8	15
Aluminum Silicate (Andalusite)	49	C1/2-35S	L-S	3	.8	30A
Aluminum Sulfate	45-58	C1/2-25	L-S-B	1	1.0	45
Ammonium Chloride, Crystalline	45-52	A100-45FRS	L-S	3	.7	30A
Ammonium Nitrate	45-62	A40-35NTU	H	3	1.3	30A
Ammonium Sulfate	45-58	C1/2-35FOTU	L-S	1	1.0	30A
Antimony Powder	—	A100-35	H	2	1.6	30A
Apple Pomace, Dry	15	C1/2-45Y	H	2	1.0	30A
Arsenate Of Lead (See Lead Arsenate)	—	—	—	—	—	—
Arsenic Oxide (Arsenolite)	100-120	A100-35R	L-S-B	—	—	30A
Arsenic Pulverized	30	A100-25R	H	2	.8	45
Asbestos — Rock (Ore)	81	D3-37R	H	3	1.2	15
Asbestos — Shredded	20-40	E-46XY	H	2	1.0	30B
Ash, Black Ground	105	B6-35	L-S-B	1	2.0	30A
Ashes, Coal, Dry — 1/2"	35-45	C1/2-46TY	H	3	3.0	30B
Ashes, Coal, Dry — 3"	35-40	D3-46T	H	3	2.5	30B
Ashes, Coal, Wet — 1/2"	45-50	C1/2-46T	H	3	3.0	30B
Ashes, Coal, Wet — 3"	45-50	D3-46T	H	3	4.0	30B
Ashes, Fly (See Fly Ash)	—	—	—	—	—	—
Asphalt, Crushed — 1/2"	45	C1/2-45	H	2	2.0	30A
Bagasse	7-10	E-45RVXY	L-S-B	2	1.5	30A
Bakelite, Fine	30-45	B6-25	L-S-B	1	1.4	45
Baking Powder	40-55	A100-35	S	1	.6	30A
Baking Soda (Sodium Bicarbonate)	40-55	A100-25	S	1	.6	45
Barite (Barium Sulfate) + 1/2" — 3"	120-180	D3-36	H	3	2.6	30B
Barite, Powder	120-180	A100-35X	H	2	2.0	30A
Barium Carbonate	72	A100-45R	H	2	1.6	30A
Bark, Wood, Refuse	10-20	E-45TVY	H	3	2.0	30A
Barley, Fine, Ground	24-38	B6-35	L-S-B	1	.4	30A
Barley, Malted	31	C1/2-35	L-S-B	1	.4	30A
Barley, Meal	28	C1/2-35	L-S-B	1	.4	30A
Barley, Whole	36-48	B6-25N	L-S-B	1	.5	45
Basalt	80-105	B6-27	H	3	1.8	15
Bauxite, Dry, Ground	68	B6-25	H	2	1.8	45
Bauxite, Crushed — 3"	75-85	D3-36	H	3	2.5	30B
Beans, Castor, Meal	35-40	B6-35W	L-S-B	1	.8	30A
Beans, Castor, Whole Shelled	36	C1/2-15W	L-S-B	1	.5	45
Beans, Navy, Dry	48	C1/2-15	L-S-B	1	.5	45
Beans, Navy, Steeped	60	C1/2-25	L-S-B	1	.8	45
Bentonite, Crude	34-40	D3-45X	H	2	1.2	30A

Table 1-2 Material Characteristics (Cont'd)



Material	Weight lbs. per cu. ft	Intermediate Material Code	Bearing Selection	Component Series	Material Factor Fm	Trough Loading
Bentonite, -100 Mesh	50-60	A100-25MXY	H	2	0.7	45
Benzene Hexachloride	56	A100-45R	L-S-B	1	0.6	30A
Bicarbonate of Soda (Baking Soda)	—	—	S	1	0.6	—
Blood, Dried	35-45	D3-45U	H	2	2	30A
Blood, Ground, Dried	30	A100-35U	L-S	1	1	30A
Bone Ash (Tricalcium Phosphate)	40-50	A100-45	L-S	1	1.6	30A
Boneblack	20-25	A100-25Y	L-S	1	1.5	45
Bonechar	27-40	B6-35	L-S	1	1.6	30A
Bonemeal	50-60	B6-35	H	2	1.7	30A
Bones, Whole*	35-50	E-45V	H	2	3	30A
Bones, Crushed	35-50	D3-45	H	2	2	30A
Bones, Ground	50	B6-35	H	2	1.7	30A
Borate of Lime	60	A100-35	L-S-B	1	0.6	30A
Borax, Fine	45-55	B6-25T	H	3	0.7	30B
Borax Screening — 1/2"	55-60	C1/2-35	H	2	1.5	30A
Borax, 1 1/2" - 2" Lump	55-60	D3-35	H	2	1.8	30A
Borax, 2" - 3" Lump	60-70	D3-35	H	2	2	30A
Boric Acid, Fine	55	B6-25T	H	3	0.8	30A
Boron	75	A100-37	H	2	1	30B
Bran, Rice — Rye — Wheat	16-20	B6-35NY	L-S-B	1	0.5	30A
Braunite (Manganese Oxide)	120	A100-36	H	2	2	30B
Bread Crumbs	20-25	B6-35PQ	L-S-B	1	0.6	30A
Brewer's Grain, Spent, Dry	14-30	C1/2-45	L-S-B	1	0.5	30A
Brewer's Grain, Spent, Wet	55-60	C1/2-45T	L-S	2	0.8	30A
Brick, Ground — 1/8"	100-120	B6-37	H	3	2.2	15
Bronze Chips	30-50	B6-45	H	2	2	30A
Buckwheat	37-42	B6-25N	L-S-B	1	0.4	45
Calcine, Flour	75-85	A100-35	L-S-B	1	0.7	30A
Calcium Carbide	70-90	D3-25N	H	2	2	30A
Calcium Carbonate (See Limestone)	—	—	—	—	—	—
Calcium Fluoride (See Fluorspar)	—	—	—	—	—	—
Calcium Hydrate (See Lime, Hydrated)	—	—	—	—	—	—
Calcium Hydroxide (See Lime, Hydrated)	—	—	—	—	—	—
Calcium Lactate	26-29	D3-45QTR	L-S	2	0.6	30A
Calcium Oxide (See Lime, Unslaked)	—	—	—	—	—	—
Calcium Phosphate	40-50	A100-45	L-S-B	1	1.6	30A
Calcium Sulfate (See Gypsum)	—	—	—	—	—	—
Carbon, Activated, Dry Fine*	—	—	—	—	—	—
Carbon Black, Pelleted*	—	—	—	—	—	—
Carbon Black, Powder*	—	—	—	—	—	—
Carborundum	100	D3-27	H	3	3	15
Casein	36	B6-35	H	2	1.6	30A
Cashew Nuts	32-37	C1/2-45	H	2	0.7	30A
Cast Iron, Chips	130-200	C1/2-45	H	2	4	30A
Caustic Soda	88	B6-35RSU	H	3	1.8	30A
Caustic Soda, Flakes	47	C1/2-45RSUX	L-S	3	1.5	30A
Celite (See Diatomaceous Earth)	—	—	—	—	—	—
Cement, Clinker	75-95	D3-36	H	3	1.8	30B
Cement, Mortar	133	B6-35Q	H	3	3	30A
Cement, Portland	94	A100-26M	H	2	1.4	30B
Cement, Aerated (Portland)	60-75	A100-16M	H	2	1.4	30B
Cerrusite (See Lead Carbonate)	—	—	—	—	—	—
Chalk, Crushed	75-95	D3-25	H	2	1.9	30A
Chalk, Pulverized	67-75	A100-25MXY	H	2	1.4	45
Charcoal, Ground	18-28	A100-45	H	2	1.2	30A
Charcoal, Lumps	18-28	D3-45Q	H	2	1.4	30A

*Consult Factory

Material	Weight lbs. per cu. ft	Intermediate Material Code	Bearing Selection	Component Series	Material Factor Fm	Trough Loading
Chocolate, Cake Pressed	40-45	D3-25	S	2	1.5	30A
Chrome Ore	125-140	D3-36	H	3	2.5	30B
Cinders, Blast Furnace	57	D3-36T	H	3	1.9	30B
Cinders, Coal	40	D3-36T	H	3	1.8	30B
Clay (See Bentonite, Diatomaceous Earth, Fuller's Earth, Kaolin & Marl)	—	—	—	—	—	—
Clay, Ceramic, Dry, Fines	60-80	A100-35P	L-S-B	1	1.5	30A
Clay, Calcined	80-100	B6-36	H	3	2.4	30B
Clay, Brick, Dry, Fines	100-120	C1/2-36	H	3	2.0	30B
Clay, Dry, Lumpy	60-75	D3-35	H	2	1.8	30A
Clinker, Cement (See Cement Clinker)	—	—	—	—	—	—
Clover Seed	45-48	B6-25N	L-S-B	1	.4	45
Coal, Anthracite (River & Culm)	55-61	B6-35TY	L-S	2	1.0	30A
Coal, Anthracite, Sized-1/2"	49-61	C1/2-25	L-S	2	1.0	45
Coal, Bituminous, Mined	40-60	D3-35LNXY	L-S	1	.9	30A
Coal, Bituminous, Mined, Sized	45-50	D3-35QV	L-S	1	1.0	30A
Coal, Bituminous, Mined, Slack	43-50	C1/2-45T	L-S	2	.9	30A
Coal, Lignite	37-45	D3-35T	H	2	1.0	30A
Cocoa Beans	30-45	C1/2-25Q	L-S	1	.5	45
Cocoa, Nibs	35	C1/2-25	H	2	.5	45
Cocoa, Powdered	30-35	A100-45XY	S	1	.9	30A
Cocoonut, Shredded	20-22	E-45	S	2	1.5	30A
Coffee, Chaff	20	B6-25MY	L-S	1	1.0	45
Coffee, Green Bean	25-32	C1/2-25PQ	L-S	1	.5	45
Coffee, Ground, Dry	25	A40-35P	L-S	1	.6	30A
Coffee, Ground, Wet	35-45	A40-45X	L-S	1	.6	30A
Coffee, Roasted Bean	20-30	C1/2-25PQ	S	1	.4	45
Coffee, Soluble	19	A40-35PUY	S	1	.4	45
Coke, Breeze	25-35	C1/2-37	H	3	1.2	15
Coke, Loose	23-35	D7-37	H	3	1.2	15
Coke, Petrol, Calcined	35-45	D7-37	H	3	1.3	15
Compost	30-50	D7-45TV	L-S	3	1.0	30A
Concrete, Pre-Mix Dry	85-120	C1/2-36U	H	3	3.0	30B
Copper Ore	120-150	DX-36	H	3	4.0	30B
Copper Ore, Crushed	100-150	D3-36	H	3	4.0	30B
Copper Sulphate, (Bluestone)	75-95	C1/2-35S	L-S	2	1.0	30A
Copperas (See Ferrous Sulphate)	—	—	—	—	—	—
Copra, Cake Ground	40-45	B6-45HW	L-S-B	1	.7	30A
Copra, Cake, Lumpy	25-30	D3-35HW	L-S-B	2	.8	30A
Copra, Lumpy	22	E-35HW	L-S-B	2	1.0	30A
Copra, Meal	40-45	B6-35HW	H	2	.7	30A
Cork, Fine Ground	5-15	B6-35JNY	L-S-B	1	.5	30A
Cork, Granulated	12-15	C1/2-35JY	L-S-B	1	.5	30A
Corn, Cracked	40-50	B6-25P	L-S-B	1	.7	45
Corn Cobs, Ground	17	C1/2-25Y	L-S-B	1	.6	45
Corn Cobs, Whole*	12-15	E-35	L-S	2		30A
Corn Ear*	56	E-35	L-S	2		30A
Corn Germ	21	B6-35PY	L-S-B	1	.4	30A
Corn Grits	40-45	B6-35P	L-S-B	1	.5	30A
Cornmeal	32-40	B6-35P	L-S	1	.5	30A
Corn Oil, Cake	25	D7-45HW	L-S	1	.6	30A
Corn Seed	45	C1/2-25PQ	L-S-B	1	.4	45
Corn Shelled	45	C1/2-25	L-S-B	1	.4	45
Corn Sugar	30-35	B6-35PU	S	1	1.0	30A
Cottonseed, Cake, Crushed	40-45	C1/2-45HW	L-S	1	1.0	30A
Cottonseed, Cake, Lumpy	40-45	D7-45HW	L-S	2	1.0	30A

Table 1-2 Material Characteristics (Cont'd)



Material	Weight lbs. per cu. ft	Intermediate Material Code	Bearing Selection	Component Series	Material Factor Fm	Trough Loading
Cottonseed, Dry, Delinted	22-40	C1/2-25X	L-S	1	.6	45
Cottonseed, Dry, Not Delinted	18-25	C1/2-45XY	L-S	1	.9	30A
Cottonseed, Flakes	20-25	C1/2-35HWY	L-S	1	.8	30A
Cottonseed, Hulls	12	B6-35Y	L-S	1	.9	30A
Cottonseed, Meal, Expeller	25-30	B6-45HW	L-S	3	.5	30A
Cottonseed, Meal, Extracted	35-40	B6-45HW	L-S	1	.5	30A
Cottonseed, Meats, Dry	40	B6-35HW	L-S	1	.6	30A
Cottonseed, Meats, Rolled	35-40	C1/2-45HW	L-S	1	.6	30A
Cracklings, Crushed	40-50	D3-45HW	L-S-B	2	1.3	30A
Cryolite, Dust	75-90	A100-36L	H	2	2.0	30B
Cryolite, Lumpy	90-110	D16-36	H	2	2.1	30B
Cullet, Fine	80-120	C1/2-37	H	3	2.0	15
Cullet, Lump	80-120	D16-37	H	3	2.5	15
Culm, (See Coal, Anthracite)	—	—	—	—	—	—
Cupric Sulphate (Copper Sulfate)	—	—	—	—	—	—
Detergent (See Soap Detergent)	—	—	—	—	—	—
Diatomaceous Earth	11-17	A40-36Y	H	3	1.6	30B
Dicalcium Phosphate	40-50	A40-35	L-S-B	1	1.6	30A
Disodium Phosphate	25-31	A40-35	H	3	.5	30A
Distiller's Grain, Spent Dry	30	B6-35	H	2	.5	30A
Distiller's Grain, Spent Wet	40-60	C1/2-45V	L-S	3	.8	30A
Dolomite, Crushed	80-100	C1/2-36	H	2	2.0	30B
Dolomite, Lumpy	90-100	DX-36	H	2	2.0	30B
Earth, Loam, Dry, Loose	76	C1/2-36	H	2	1.2	30B
Ebonite, Crushed	63-70	C1/2-35	L-S-B	1	.8	30A
Egg Powder	16	A40-35MPY	S	1	1.0	30A
Epsom Salts (Magnesium Sulfate)	40-50	A40-35U	L-S-B	1	.8	30A
Feldspar, Ground	65-80	A100-37	H	2	2.0	15
Feldspar, Lumps	90-100	D7-37	H	2	2.0	15
Feldspar, Powder	100	A200-36	H	2	2.0	30B
Feldspar, Screenings	75-80	C1/2-37	H	2	2.0	15
Ferrous Sulfide — 1/2"	120-135	C1/2-26	H	2	2.0	30B
Ferrous Sulfide — 100M	105-120	A100-36	H	2	2.0	30B
Ferrous Sulphate	50-75	C1/2-35U	H	2	1.0	30A
Fish Meal	35-40	C1/2-45HP	L-S-B	1	1.0	30A
Fish Scrap	40-50	D7-45H	L-S-B	2	1.5	30A
Flaxseed	43-45	B6-35X	L-S-B	1	.4	30A
Flaxseed Cake (Linseed Cake)	48-50	D7-45W	L-S	2	.7	30A
Flaxseed Meal (Linseed Meal)	25-45	B6-45W	L-S	1	.4	30A
Flour Wheat	33-40	A40-45LP	S	1	.6	30A
Flue Dust, Basic Oxygen Furnace	45-60	A40-36LM	H	3	3.5	30B
Flue Dust, Blast Furnace	110-125	A40-36	H	3	3.5	30B
Flue Dust, Boiler H. Dry	30-45	A40-36LM	H	3	2.0	30B
Fluorspar, Fine (Calcium Fluoride)	80-100	B6-36	H	2	2.0	30B
Fluorspar, Lumps	90-110	D7-36	H	2	2.0	30B
Fly Ash	30-45	A40-36M	H	3	2.0	30B
Foundry Sand, Dry (See Sand)	—	—	—	—	—	—
Fuller's Earth, Dry, Raw	30-40	A40-25	H	2	2.0	15
Fuller's Earth, Oily, Spent	60-65	C1/2-450W	H	3	2.0	30A
Fuller's Earth, Calcined	40	A100-25	H	3	2.0	15
Galena (See Lead Sulfide)	—	—	—	—	—	—
Gelatine, Granulated	32	B6-35PU	S	1	.8	30A
Gilsonite	37	C1/2-35	H	3	1.5	30A
Glass, Batch	80-100	C1/2-37	H	3	2.5	15
Glue, Ground	40	B6-45U	H	2	1.7	30A
Glue, Pearl	40	C1/2-35U	L-S-B	1	.5	30A

Material	Weight lbs. per cu. ft	Intermediate Material Code	Bearing Selection	Component Series	Material Factor Fm	Trough Loading
Glue, Veg. Powdered	40	A40-45U	L-S-B	1	.6	30A
Gluten, Meal	40	B6-35P	L-S	1	.6	30A
Granite, Fine	80-90	C1/2-27	H	3	2.5	15
Grape Pomace	15-20	D3-45U	H	2	1.4	30A
Graphite Flake	40	B6-25LP	L-S-B	1	.5	45
Graphite Flour	28	A100-35LMP	L-S-B	1	.5	30A
Graphite Ore	65-75	DX-35L	H	2	1.0	30A
Guano Dry*	70	C1/2-35	L-S	3	2.0	30A
Gypsum, Calcined	55-60	B6-35U	H	2	1.6	30A
Gypsum, Calcined, Powdered	60-80	A100-35U	H	2	2.0	30A
Gypsum, Raw — 1"	70-80	D3-25	H	2	2.0	30A
Hay, Chopped*	8-12	C1/2-35JY	L-S	2	1.6	30A
Hexanedioic Acid (See Adipic Acid)	—	—	—	—	—	—
Hominy, Dry	35-50	C1/2-25	L-S-B	1	.4	45
Hops, Spent, Dry	35	D3-35	L-S-B	2	1.0	30A
Hops, Spent, Wet	50-55	D3-45V	L-S	2	1.5	30A
Ice, Crushed	35-45	D3-35Q	L-S	2	.4	30A
Ice, Flaked*	40-45	C1/2-35Q	S	1	.6	30A
Ice, Cubes	33-35	D3-35Q	S	1	.4	30A
Ice, Shell	33-35	D3-45Q	S	1	.4	30A
Ilmenite Ore	140-160	D3-37	H	3	2.0	15
Iron Ore Concentrate	120-180	A40-37	H	3	2.2	15
Iron Oxide Pigment	25	A100-36LMP	H	2	1.0	30B
Iron Oxide, Millscale	75	C1/2-36	H	2	1.6	30B
Iron Pyrites (See Ferrous Sulfide)	—	—	—	—	—	—
Iron Sulphate (See Ferrous Sulfate)	—	—	—	—	—	—
Iron Sulfide (See Ferrous Sulfide)	—	—	—	—	—	—
Iron Vitriol (See Ferrous Sulfate)	—	—	—	—	—	—
Kafir (Corn)	40-45	C1/2-25	H	3	.5	45
Kaolin Clay	63	D3-25	H	2	2.0	30A
Kaolin Clay-Talc	32-56	A40-35LMP	H	2	2.0	30A
Kryalith (See Cryolite)	—	—	—	—	—	—
Lactose	32	A40-35PU	S	1	.6	30A
Lamp Black (See Carbon Black)	—	—	—	—	—	—
Lead Arsenate	72	A40-35R	L-S-B	1	1.4	30A
Lead Arsenite	72	A40-35R	L-S-B	1	1.4	30A
Lead Carbonate	240-260	A40-35R	H	2	1.0	30A
Lead Ore — 1/8"	200-270	B6-35	H	3	1.4	30A
Lead Ore — 1/2"	180-230	C1/2-36	H	3	1.4	30B
Lead Oxide (Red Lead) — 100 Mesh	30-150	A100-35P	H	2	1.2	30A
Lead Oxide (Red Lead) — 200 Mesh	30-180	A200-35LP	H	2	1.2	30A
Lead Sulphide — 100 Mesh	240-260	A100-35R	H	2	1.0	30A
Lignite (See Coal Lignite)	—	—	—	—	—	—
Limanite, Ore, Brown	120	C1/2-47	H	3	1.7	15
Lime, Ground, Unslaked	60-65	B6-35U	L-S-B	1	.6	30A
Lime Hydrated	40	B6-35LM	H	2	.8	30A
Lime, Hydrated, Pulverized	32-40	A40-35LM	L-S	1	.6	30A
Lime, Pebble	53-56	C1/2-25HU	L-S	2	2.0	45
Limestone, Agricultural	68	B6-35	H	2	2.0	30A
Limestone, Crushed	85-90	DX-36	H	2	2.0	30B
Limestone, Dust	55-95	A40-46MY	H	2	1.6-2.0	30B
Lindane (Benzene Hexachloride)	—	—	—	—	—	—
Linseed (See Flaxseed)	—	—	—	—	—	—
Litharge (Lead Oxide)	—	—	—	—	—	—
Lithopone	45-50	A325-35MR	L-S	1	1.0	30A
Maize (See Milo)	—	—	—	—	—	—

*Consult Factory

Table 1-2 Material Characteristics (Cont'd)



Material	Weight lbs. per cu. ft	Intermediate Material Code	Bearing Selection	Component Series	Material Factor Fm	Trough Loading
Malt, Dry, Ground	20-30	B6-35NP	L-S-B	1	.5	30A
Malt, Meal	36-40	B6-25P	L-S-B	1	.4	45
Malt, Dry Whole	20-30	C1/2-35N	L-S-B	1	.5	30A
Malt, Sprouts	13-15	C1/2-35P	L-S-B	1	.4	30A
Magnesium Chloride (Magnesite)	33	C1/2-45	L-S	1	1.0	30A
Manganese Dioxide*	70-85	A100-35NRT	L-S	2	1.5	30A
Manganese Ore	125-140	DX-37	H	3	2.0	15
Manganese Oxide	120	A100-36	H	2	2.0	30B
Manganese Sulfate	70	C1/2-37	H	3	2.4	15
Marble, Crushed	80-95	B6-37	H	3	2.0	15
Marl, (Clay)	80	DX-36	H	2	1.6	30B
Meat, Ground	50-55	E-45HQT	L-S	2	1.5	30A
Meat, Scrap (w/bone)	40	E-46H	H	2	1.5	30B
Mica, Flakes	17-22	B6-16MY	H	2	1.0	30B
Mica, Ground	13-15	B6-36	H	2	.9	30B
Mica, Pulverized	13-15	A100-36M	H	2	1.0	30B
Milk, Dried, Flake	5-6	B6-35PUY	S	1	.4	30A
Milk, Malted	27-30	A40-45PX	S	1	.9	30A
Milk, Powdered	20-45	B6-25PM	S	1	.5	45
Milk Sugar	32	A100-35PX	S	1	.6	30A
Milk, Whole, Powdered	20-36	B6-35PUX	S	1	.5	30A
Mill Scale (Steel)	120-125	E-46T	H	3	3.0	30B
Milo, Ground	32-36	B6-25	L-S-B	1	.5	45
Milo Maize (Kafir)	40-45	B6-15N	L-S-B	1	.4	45
Molybdenite Powder	107	B6-26	H	2	1.5	30B
Monosodium Phosphate	50	B6-36	H	2	.6	30B
Mortar, Wet*	150	E-46T	H	3	3.0	30B
Mustard Seed	45	B6-15N	L-S-B	1	.4	45
Naphthalene Flakes	45	B6-35	L-S-B	1	.7	30A
Niacin (Nicotinic Acid)	35	A40-35P	H	2	2.5	30A
Oats	26	C1/2-25MN	L-S-B	1	.4	45
Oats, Crimped	19-26	C1/2-35	L-S-B	1	.5	30A
Oats, Crushed	22	B6-45NY	L-S-B	1	.6	30A
Oats, Flour	35	A100-35	L-S-B	1	.5	30A
Oat Hulls	8-12	B6-35NY	L-S-B	1	.5	30A
Oats, Rolled	19-24	C1/2-35NY	L-S-B	1	.6	30A
Oleo Margarine (Margarine)	59	E-45HKPW	L-S	2	.4	30A
Orange Peel, Dry	15	E-45	L-S	2	1.5	30A
Oxalic Acid Crystals — Ethane Diacid Crystals	60	B6-35QS	L-S	1	1.0	30A
Oyster Shells, Ground	50-60	C1/2-36T	H	3	1.6-2.0	30B
Oyster Shells, Whole	80	D3-36TV	H	3	2.1-2.5	30B
Paper Pulp (4% or less)	62	E-45	L-S	2	1.5	30A
Paper Pulp (6% to 15%)	60-62	E-45	L-S	2	1.5	30A
Paraffin Cake — 1/2"	45	C1/2-45K	L-S	1	.6	30A
Peanuts, Clean, in shell	15-20	D3-35Q	L-S	2	.6	30A
Peanut Meal	30	B6-35P	S	1	.6	30A
Peanuts, Raw, Uncleaned (unshelled)	15-20	D3-36Q	H	3	.7	30B
Peanuts, Shelled	35-45	C1/2-35Q	S	1	.4	30A
Peas, Dried	45-50	C1/2-15NQ	L-S-B	1	.5	45
Perlite — Expanded	8-12	C1/2-36	H	2	.6	30B
Phosphate Acid Fertilizer	60	B6-25T	L-S	2	1.4	45
Phosphate Disodium (See Sodium Phosphate)	—	—	—	—	—	—
Phosphate Rock, Broken	75-85	DX-36	H	2	2.1	30B
Phosphate Rock, Pulverized	60	B6-36	H	2	1.7	30B
Phosphate Sand	90-100	B6-37	H	3	2.0	15
Plaster of Paris (See Gypsum)	—	—	—	—	—	—

*Consult Factory

Material	Weight lbs. per cu. ft	Intermediate Material Code	Bearing Selection	Component Series	Material Factor Fm	Trough Loading
Plumbago (See Graphite)	—	—	—	—	—	—
Polystyrene Beads	40	B6-35PQ	S	1	.4	30A
Polyvinyl, Chloride Powder	20-30	A100-45KT	S	2	1.0	30A
Polyvinyl, Chloride Pellets	20-30	E-45KPQT	S	1	.6	30A
Polyethylene, Resin Pellets	30-35	C1/2-45Q	L-S	1	.4	30A
Potash (Muriate) Dry	70	B6-37	H	3	2.0	15
Potash (Muriate) Mine Run	75	DX-37	H	3	2.2	15
Potassium Carbonate	51	B6-36	H	2	1.0	30B
Potassium Chloride Pellets	120-130	C1/2-25TU	H	3	1.6	45
Potassium Nitrate — 1/2"	76	C1/2-16NT	H	3	1.2	30B
Potassium Nitrate — 1/8"	80	B6-26NT	H	3	1.2	30B
Potassium Sulfate	42-48	B6-46X	H	2	1.0	30B
Potato Flour	48	A200-35MNP	L-S	1	.5	30A
Pumice — 1/8"	42-48	B6-46	H	3	1.6	30B
Pyrite, Pellets	120-130	C1/2-26	H	3	2.0	30B
Quartz — 100 Mesh	70-80	A100-27	H	3	1.7	15
Quartz — 1/2"	80-90	C1/2-27	H	3	2.0	15
Rice, Bran	20	B6-35NY	L-S-B	1	.4	30A
Rice, Grits	42-45	B6-35P	L-S-B	1	.4	30A
Rice, Polished	30	C1/2-15P	L-S-B	1	.4	45
Rice, Hulled	45-49	C1/2-25P	L-S-B	1	.4	45
Rice, Hulls	20-21	B6-35NY	L-S-B	1	.4	30A
Rice, Rough	32-36	C1/2-35N	L-S-B	1	.6	30A
Rosin — 1/2"	65-68	C1/2-45Q	L-S-B	1	1.5	30A
Rubber, Reclaimed Ground	23-50	C1/2-45	L-S-B	1	.8	30A
Rubber, Pelleted	50-55	D3-45	L-S-B	2	1.5	30A
Rye	42-48	B6-15N	L-S-B	1	.4	45
Rye Bran	15-20	B6-35Y	L-S-B	1	.4	45
Rye Feed	33	B6-35N	L-S-B	1	.5	30A
Rye Meal	35-40	B6-35	L-S-B	1	.5	30A
Rye Middlings	42	B6-35	L-S	1	.5	30A
Rye, Shorts	32-33	C1/2-35	L-S	2	.5	30A
Safflower, Cake	50	D3-26	H	2	.6	30B
Safflower, Meal	50	B6-35	L-S-B	1	.6	30A
Safflower Seed	45	B6-15N	L-S-B	1	.4	45
Saffron (See Safflower)	—	—	—	—	—	—
Sal Ammoniac (Ammonium Chloride)	—	—	—	—	—	—
Salt Cake, Dry Coarse	85	B6-36TU	H	3	2.1	30B
Salt Cake, Dry Pulverized	65-85	B6-36TU	H	3	1.7	30B
Salicylic Acid	29	B6-37U	H	3	.6	15
Salt, Dry Coarse	45-60	C1/2-36TU	H	3	1.0	30B
Salt, Dry Fine	70-80	B6-36TU	H	3	1.7	30B
Saltpeter — (See Potassium Nitrate)	—	—	—	—	—	—
Sand Dry Bank (Damp)	110-130	B6-47	H	3	2.8	15
Sand Dry Bank (Dry)	90-110	B6-37	H	3	1.7	15
Sand Dry Silica	90-100	B6-27	H	3	2.0	15
Sand Foundry (Shake Out)	90-100	D3-37Z	H	3	2.6	15
Sand (Resin Coated) Silica	104	B6-27	H	3	2.0	15
Sand (Resin Coated) Zircon	115	A100-27	H	3	2.3	15
Sawdust, Dry	10-13	B6-45UX	L-S-B	1	1.4	15
Sea — Coal	65	B6-36	H	2	1.0	30B
Sesame Seed	27-41	B6-26	H	2	.6	30B
Shale, Crushed	85-90	C1/2-36	H	2	2.0	30B
Shellac, Powdered or Granulated	31	B6-35P	S	1	.6	30A
Silicon Dioxide (See Quartz)	—	—	—	—	—	—
Silica, Flour	80	A40-46	H	2	1.5	30B

Table 1-2

Material Characteristics (Cont'd)



Material	Weight lbs. per cu. ft	Intermediate Material Code	Bearing Selection	Component Series	Material Factor Fm	Trough Loading
Silica Gel + 1/2" - 3"	45	D3-37HKQU	H	3	2.0	15
Slag, Blast Furnace Crushed	130-180	D3-37Y	H	3	2.4	15
Slag, Furnace Granular, Dry	60-65	C1/2-37	H	3	2.2	15
Slate, Crushed, — 1/2"	80-90	C1/2-36	H	2	2.0	30B
Slate, Ground, — 1/8"	82-85	B6-36	H	2	1.6	30B
Sludge, Sewage, Dried	40-50	E-47TW	H	3	.8	15
Sludge, Sewage, Dry Ground	45-55	B-46S	H	2	.8	30B
Soap, Beads or Granules	15-35	B6-35Q	L-S-B	1	.6	30A
Soap, Chips	15-25	C1/2-35Q	L-S-B	1	.6	30A
Soap Detergent	15-50	B6-35FQ	L-S-B	1	.8	30A
Soap, Flakes	5-15	B6-35QXY	L-S-B	1	.6	30A
Soap, Powder	20-25	B6-25X	L-S-B	1	.9	45
Soapstone, Talc, Fine	40-50	A200-45XY	L-S-B	1	2.0	30A
Soda Ash, Heavy	55-65	B6-36	H	2	2.0	30B
Soda Ash, Light	20-35	A40-36Y	H	2	1.6	30B
Sodium Aluminate, Ground	72	B6-36	H	2	1.0	30B
Sodium Aluminum Fluoride (See Kryolite)	—	—	—	—	—	—
Sodium Aluminum Sulphate*	75	A100-36	H	2	1.0	30B
Sodium Bentonite (See Bentonite)	—	—	—	—	—	—
Sodium Bicarbonate (See Baking Soda)	—	—	—	—	—	—
Sodium Chloride (See Salt)	—	—	—	—	—	—
Sodium Carbonate (See Soda Ash)	—	—	—	—	—	—
Sodium Hydrate (See Caustic Soda)	—	—	—	—	—	—
Sodium Hydroxide (See Caustic Soda)	—	—	—	—	—	—
Sodium Borate (See Borax)	—	—	—	—	—	—
Sodium Nitrate	70-80	D3-25NS	L-S	2	1.2	30A
Sodium Phosphate	50-60	A-35	L-S	1	.9	30A
Sodium Sulfate (See Salt Cake)	—	—	—	—	—	—
Sodium Sulfite	96	B6-46X	H	2	1.5	30B
Sorghum, Seed (See Kafir or Milo)	—	—	—	—	—	—
Soybean, Cake	40-43	D3-35W	L-S-B	2	1.0	30A
Soybean, Cracked	30-40	C1/2-36NW	H	2	.5	30B
Soybean, Flake, Raw	18-25	C1/2-35Y	L-S-B	1	.8	30A
Soybean, Flour	27-30	A40-35MN	L-S-B	1	.8	30A
Soybean Meal, Cold	40	B6-35	L-S-B	1	.5	30A
Soybean Meal Hot	40	B6-35T	L-S	2	.5	30A
Soybeans, Whole	45-50	C1/2-26NW	H	2	1.0	30B
Starch	25-50	A40-15M	L-S-B	1	1.0	45
Steel Turnings, Crushed	100-150	D3-46WV	H	3	3.0	30B
Sugar Beet, Pulp, Dry	12-15	C1/2-26	H	2	.9	30B
Sugar Beet, Pulp, Wet	25-45	C1/2-35X	L-S-B	1	1.2	30A
Sugar, Refined, Granulated Dry	50-55	B6-35PU	S	1	1.0-1.2	30A
Sugar, Refined, Granulated Wet	55-65	C1/2-35X	S	1	1.4-2.0	30A
Sugar, Powdered	50-60	A100-35PX	S	1	.8	30A
Sugar, Raw	55-65	B6-35PX	S	1	1.5	30A
Sulphur, Crushed — 1/2"	50-60	C1/2-35N	L-S	1	.8	30A
Sulphur, Lumpy, — 3"	80-85	D3-35N	L-S	2	.8	30A
Sulphur, Powdered	50-60	A40-35MN	L-S	1	.6	30A
Sunflower Seed	19-38	C1/2-15	L-S-B	1	.5	45
Talcum, — 1/2"	80-90	C1/2-36	H	2	.9	30B
Talcum Powder	50-60	A200-36M	H	2	.8	30B
Tanbark, Ground*	55	B6-45	L-S-B	1	.7	30A
Timothy Seed	36	B6-35NY	L-S-B	1	.6	30A
Titanium Dioxide (See Ilmenite Ore)	—	—	—	—	—	—
Tobacco, Scraps	15-25	D3-45Y	L-S	2	.8	30A
Tobacco, Snuff	30	B6-45MQ	L-S-B	1	.9	30A

*Consult Factory



Table 1-2 Material Characteristics (Cont'd)

Material	Weight lbs. per cu. ft	Intermediate Material Code	Bearing Selection	Component Series	Material Factor Fm	Trough Loading
Tricalcium Phosphate	40-50	A40-45	L-S	1	1.6	30A
Triple Super Phosphate	50-55	B6-36RS	H	3	2.0	30B
Trisodium Phosphate	60	C1/2-36	H	2	1.7	30B
Trisodium Phosphate Granular	60	B6-36	H	2	1.7	30B
Trisodium Phosphate, Pulverized	50	A40-36	H	2	1.6	30B
Tung Nut Meats, Crushed	28	D3-25W	L-S	2	.8	30A
Tung Nuts	25-30	D3-15	L-S	2	.7	30A
Urea Prills, Coated	43-46	B6-25	L-S-B	1	1.2	45
Vermiculite, Expanded	16	C1/2-35Y	L-S	1	.5	30A
Vermiculite, Ore	80	D3-36	H	2	1.0	30B
Vetch	48	B6-16N	L-S-B	1	.4	30B
Walnut Shells, Crushed	35-45	B6-36	H	2	1.0	30B
Wheat	45-48	C1/2-25N	L-S-B	1	.4	45
Wheat, Cracked	40-45	B6-25N	L-S-B	1	.4	45
Wheat, Germ	18-28	B6-25	L-S-B	1	.4	45
White Lead, Dry	75-100	A40-36MR	H	2	1.0	30B
Wood Chips, Screened	10-30	D3-45VY	L-S	2	.6	30A
Wood Flour	16-36	B6-35N	L-S	1	.4	30A
Wood Shavings	8-16	E-45VY	L-S	2	1.5	30A
Zinc, Concentrate Residue	75-80	B6-37	H	3	1.0	15
Zinc Oxide, Heavy	30-35	A100-45X	L-S	1	1.0	30A
Zinc Oxide, Light	10-15	A100-45XY	L-S	1	1.0	30A

*Consult Factory

Selection of Conveyor Size and Speed



In order to determine the size and speed of a screw conveyor, it is necessary first to establish the material code number. It will be seen from what follows that this code number controls the cross-sectional loading that should be used. The various cross-sectional loadings shown in the Capacity Table (Table 1-6) are for use with the standard screw conveyor components indicated in the Component Group Selection Guide on page H-21 and are for use where the conveying operation is controlled with volumetric feeders and where the material is uniformly fed into the conveyor housing and discharged from it. Check lump size limitations before choosing conveyor diameter. See Table 1-7 on page H-18.

Capacity Table

The capacity table, (Table 1-6), gives the capacities in cubic feet per hour at one revolution per minute for various size screw conveyors for four cross-sectional loadings. Also shown are capacities in cubic feet per hour at the maximum recommended revolutions per minute.

The capacity values given in the table will be found satisfactory for most applications. Where the capacity of a screw conveyor is very critical, especially when handling a material not listed in Table 1-2, it is best to consult our Engineering Department.

The maximum capacity of any size screw conveyor for a wide range of materials, and various conditions of loading, may be obtained from Table 1-6 by noting the values of cubic feet per hour at maximum recommended speed.

Conveyor Speed

For screw conveyors with screws having standard pitch helical flights the conveyor speed may be calculated by the formula:

$$N = \frac{\text{Required capacity, cubic feet per hour}}{\text{Cubic feet per hour at 1 revolution per minute}}$$

$$N = \text{Revolutions per minute of screw} \\ \text{(but not greater than the maximum recommended speed.)}$$

For the calculation of conveyor speeds where special types of screws are used, such as short pitch screws, cut flights, cut and folded flights and ribbon flights, an equivalent required capacity must be used, based on factors in the Tables 1-3, 4, 5.

Factor CF_1 relates to the pitch of the screw. Factor CF_2 relates to the type of the flight. Factor CF_3 relates to the use of mixing paddles within the flight pitches.

The equivalent capacity then is found by multiplying the required capacity by the capacity factors. See Tables 1-3, 4, 5 for capacity factors.

$$\left(\begin{array}{c} \text{Equiv. Capacity} \\ \text{Cubic Feet Per Hour} \end{array} \right) = \left(\begin{array}{c} \text{Required Capacity} \\ \text{Cubic Feet Per Hour} \end{array} \right) (CF_1) (CF_2) (CF_3)$$

Table 1-3

Special Conveyor Pitch Capacity Factor CF_1		
Pitch	Description	CF_1
Standard	Pitch = Diameter of Screw	1.00
Short	Pitch = 2/3 Diameter of Screw	1.50
Half	Pitch = 1/2 Diameter of Screw	2.00
Long	Pitch = 1 1/2 Diameter of Screw	0.67

Table 1-4

Special Conveyor Pitch Capacity Factor CF_2			
Type of Flight	Conveyor Loading		
	15%	30%	45%
Cut Flight	1.95	1.57	1.43
Cut & Folded Flight	N.R. *	3.75	2.54
Ribbon Flight	1.04	1.37	1.62

*Not recommended
 If none of the above flight modifications are used: $CF_2 = 1.0$

Table 1-5

Special Conveyor Pitch Capacity Factor CF_3					
Standard Paddles at 45° Reverse Pitch	Paddles Per Pitch				
	None	1	2	3	4
Factor CF_3	1.00	1.08	1.16	1.24	1.32

Capacity Table

Horizontal Screw Conveyors

(Consult Factory for Inclined Conveyors)

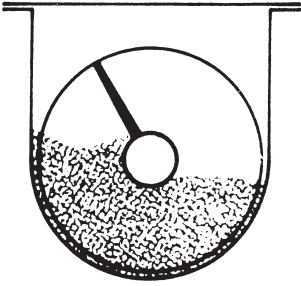
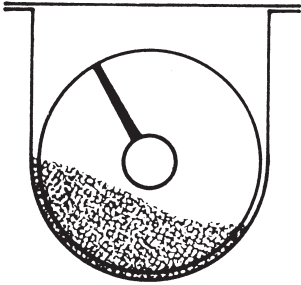
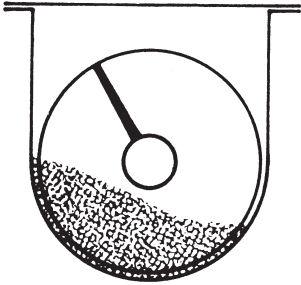
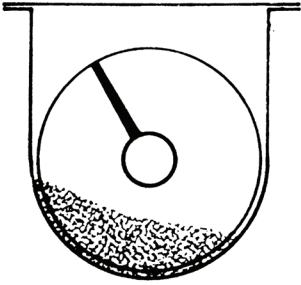

Table 1-6

Trough Loading	Screw Diameter Inch	Capacity Cubic Feet Per Hour (Full Pitch)		Max. RPM
		At One RPM	At Max. RPM	
45% 	4	0.62	114	184
	6	2.23	368	165
	9	8.20	1270	155
	10	11.40	1710	150
	12	19.40	2820	145
	14	31.20	4370	140
	16	46.70	6060	130
	18	67.60	8120	120
	20	93.70	10300	110
	24	164.00	16400	100
	30	323.00	29070	90
	36	553.20	4142	75
30% A 	4	0.41	53	130
	6	1.49	180	120
	9	5.45	545	100
	10	7.57	720	95
	12	12.90	1160	90
	14	20.80	1770	85
	16	31.20	2500	80
	18	45.00	3380	75
	20	62.80	4370	70
	24	109.00	7100	65
	30	216.00	12960	60
	36	368.80	18400	50
30% B 	4	0.41	29	72
	6	1.49	90	60
	9	5.45	300	55
	10	7.60	418	55
	12	12.90	645	50
	14	20.80	1040	50
	16	31.20	1400	45
	18	45.00	2025	45
	20	62.80	2500	40
	24	109.00	4360	40
	30	216.00	7560	35
	36	368.80	11064	30
15% 	4	0.21	15	72
	6	0.75	45	60
	9	2.72	150	55
	10	3.80	210	55
	12	6.40	325	50
	14	10.40	520	50
	16	15.60	700	45
	18	22.50	1010	45
	20	31.20	1250	40
	24	54.60	2180	40
	30	108.00	3780	35
	36	184.40	5537	30

The size of a screw conveyor not only depends on the capacity required, but also on the size and proportion of lumps in the material to be handled. The size of a lump is the maximum dimension it has. If a lump has one dimension much longer than its transverse cross-section, the long dimension or length would determine the lump size.

The character of the lump also is involved. Some materials have hard lumps that won't break up in transit through a screw conveyor. In that case, provision must be made to handle these lumps. Other materials may have lumps that are fairly hard, but degradable in transit through the screw conveyor, thus reducing the lump size to be handled. Still other materials have lumps that are easily broken in a screw conveyor and lumps of these materials impose no limitations.

Three classes of lump sizes are shown in TABLE 1-7 and as follows.

Class I

A mixture of lumps and fines in which not more than 10% are lumps ranging from maximum size to one half of the maximum; and 90% are lumps smaller than one half of the maximum size.

Class II

A mixture of lumps and fines in which not more than 25% are lumps ranging from the maximum size to one half of the maximum; and 75% are lumps smaller than one half of the maximum size.

Class III

A mixture of lumps only in which 95% or more are lumps ranging from maximum size to one half of the maximum size; and 5% or less are lumps less than one tenth of the maximum size.

Table 1-7

Maximum Lump Size Table (Inches)					
Screw Diameter	Pipe O.D.*	Radial Clearance △	Class I 10% Lumps Max. Lump	Class II 25% Lumps Max. Lump	Class III 95% Lumps Max. Lump
6	2 3/8	2 5/16	1 1/4	3/4	1/2
9	2 3/8	3 3/16	2 1/4	1 1/2	3/4
9	2 7/8	3 9/16	2 1/4	1 1/2	3/4
12	2 7/8	5 1/16	2 3/4	2	1
12	3 1/2	4 3/4	2 3/4	2	1
12	4	4 1/2	2 3/4	2	1
14	3 1/2	5 3/4	3 1/4	2 1/2	1 1/4
14	4	5 1/2	2 1/2	1 1/4	1 1/4
16	4	6 1/2	3 3/4	2 3/4	1 1/2
16	4 1/2	6 1/4	3 3/4	2 3/4	1 1/2
18	4	7 1/2	4 1/4	3	1 3/4
18	4 1/2	7 1/2	4 1/4	3	1 3/4
20	4	8 1/2	4 3/4	3 1/2	2
20	4 1/2	8 1/4	4 3/4	3 1/2	2
24	4 1/2	10 1/4	6	3 3/4	2 1/2
30	4 1/2	13 1/4	8	5	4
36	5 3/8	14 1/2	9 1/2	7 1/2	6

* For special pipe sizes, consult factory.

△ Radial clearance is the distance between the bottom of the trough and the bottom of the conveyor pipe.

EXAMPLE: Lump Size Limitations

To illustrate the selection of a conveyor size from the Maximum Lump Size Table, Table 1-7, consider crushed ice as the conveyed material. Refer to the material charts Table 1-2 and find crushed ice and its material code D3-35Q and weight of 35-45 lbs./C.F. D3 means that the lump size is 1/2" to 3", this is noted by referring to the material classification code chart on page H-5. From actual specifications regarding crushed ice it is known that crushed ice has a maximum lump size of 1 1/2" and only 25% of the lumps are 1 1/2". With this information refer to Table 1-7, Maximum Lump Size Table. Under the column Class II and 1 1/2" Max. lump size read across to the minimum screw diameter which will be 9".



Component Groups

To facilitate the selection of proper specifications for a screw conveyor for a particular duty, screw conveyors are broken down into three Component Groups. These groups relate both to the Material Classification Code and also to screw size, pipe size, type of bearings and trough thickness.

Referring to Table 1-2, find the component series designation of the material to be conveyed.

Having made the Component Series selection, refer to Tables 1-8, 9, 10 which give the specifications of the various sizes of conveyor screws. (The tabulated screw numbers in this table refer to standard specifications for screws found on pages H-77 – H-85 Component Section.) These standards give complete data on the screws such as the length of standard sections, minimum edge thickness of screw flight, bushing data, bolt size, bolt spacing, etc.

EXAMPLE: For a screw conveyor to handle brewers grain, spent wet, refer to the material characteristics Table 1-2. Note that the component series column refers to series 2. Refer now to page H-21, component selection, Table 1-9, component group 2. The standard shaft sizes, screw flight designations, trough gauges and cover gauges are listed for each screw diameter.

Table 1-8

Component Group 1					
Screw Diameter Inches	Coupling Diameter Inches	Screw Number		Thickness, U.S. Standard Gauge or Inches	
		Helicoid Flights	Sectional Flights	Trough	Cover
6	1 1/2	6H304	6S307	16Ga.	16Ga.
9	1 1/2	9H306	9S307	14Ga.	14Ga.
9	2	9H406	9S409	14Ga.	14Ga.
12	2	12H408	12S409	12Ga.	14Ga.
12	2 7/16	12H508	12S509	12Ga.	14Ga.
14	2 7/16	14H508	14S509	12Ga.	14Ga.
16	3	16H610	16S612	12Ga.	14Ga.
18	3	—	18S612	10Ga.	12Ga.
20	3	—	20S612	10Ga.	12Ga.
24	3 7/16	—	24S712	10Ga.	12Ga.
30	3 15/16	—	30S816	3/16"	10Ga.
36	4 7/16	—	36S916	1/4"	10Ga.

Table 1-9

Component Group 2					
Screw Diameter Inches	Coupling Diameter Inches	Screw Number		Thickness, U.S. Standard Gauge or Inches	
		Helicoid Flights	Sectional Flights	Trough	Cover
6	1 1/2	6H308	6S309	14Ga.	16Ga.
9	1 1/2	9H312	9S309	10Ga.	14Ga.
9	2	9H412	9S412	10Ga.	14Ga.
12	2	12H412	12S412	3/16"	14Ga.
12	2 7/16	12H512	12S512	3/16"	14Ga.
12	3	12H614	12S616	3/16"	14Ga.
14	2 7/16	—	14S512	3/16"	14Ga.
14	3	14H614	14S616	3/16"	14Ga.
16	3	16H614	16S616	3/16"	14Ga.
18	3	—	18S616	3/16"	12Ga.
20	3	—	20S616	3/16"	12Ga.
24	3 7/16	—	24S716	3/16"	12Ga.
30	3 15/16	—	30S824	1/4"	10Ga.
36	4 7/16	—	36S924	3/8"	3/16"

Table 1-10

Component Group 3					
Screw Diameter Inches	Coupling Diameter Inches	Screw Number		Thickness, U.S. Standard Gauge or Inches	
		Helicoid Flights	Sectional Flights	Trough	Cover
6	1 1/2	6H312	6S312	10Ga.	16Ga.
9	1 1/2	9H312	9S312	3/16"	14Ga.
9	2	9H414	9S416	3/16"	14Ga.
12	2	12H412	12S412	1/4"	14Ga.
12	2 7/16	12H512	12S512	1/4"	14Ga.
12	3	12H614	12S616	1/4"	14Ga.
14	3	—	14S624	1/4"	14Ga.
16	3	—	16S624	1/4"	14Ga.
18	3	—	18S624	1/4"	12Ga.
20	3	—	20S624	1/4"	12Ga.
24	3 7/16	—	24S724	1/4"	12Ga.
30	3 15/16	—	30S832	3/8"	10Ga.
36	4 7/16	—	36S932	3/8"	3/16"

Bearing Selection



The selection of bearing material for intermediate hangers is based on experience together with a knowledge of the characteristics of the material to be conveyed. By referring to the material characteristic tables, page H-7 thru H-15 the intermediate hanger bearing selection can be made by viewing the Bearing Selection column. The bearing selection will be made from one of the following types: B, L, S, H. The various bearing types available in the above categories can be selected from the following table.

Table 1-11

Hanger Bearing Selection				
Bearing Component Groups	Bearing Types	Recommended Coupling Shaft Material Δ	Max. Recommended Operating Temperature	F_b
B	Ball	Standard	180°F	1.0
L	Bronze	Standard	300°F	
S	<i>Martin</i> Bronze*	Standard	450°F	2.0
	Graphite Bronze	Standard	500°F	
	Oil Impregnated Bronze	Standard	200°F	
	Oil Impregnated Wood	Standard	160°F	
	Nylatron	Standard	250°F	
	Nylon	Standard	160°F	
	Teflon	Standard	250°F	
	UHMW	Standard	225°F	
	Melamine (MCB)	Standard	250°F	
	Ertalyte® Quadrent	Standard	200°F	
H	<i>Martin</i> Hard Iron*	Hardened	500°F	3.4
	Hard Iron	Hardened	500°F	4.4
	Hard Surfaced	Hardened or Special	500°F	
	Stellite	Special	500°F	
	Ceramic	Special	1,000°F	
	White Iron Alloy	Special	500°F	

* Sintered Metal. Self-lubricating.

Δ OTHER TYPES OF COUPLING SHAFT MATERIALS

Various alloys, stainless steel, and other types of shafting can be furnished as required.

Horizontal Screw Conveyors

***Consult Factory for Inclined Conveyors or Screw Feeders**

The horsepower required to operate a horizontal screw conveyor is based on proper installation, uniform and regular feed rate to the conveyor and other design criteria as determined in this book.

The horsepower requirement is the total of the horsepower to overcome friction (HP_f) and the horsepower to transport the material at the specified rate (HP_m) multiplied by the overload factor F_o and divided by the total drive efficiency, or:

$$HP_f = \frac{L N F_d f_b}{1,000,000} = \text{(Horsepower to run an empty conveyor)}$$

$$HP_m = \frac{C L W F_f F_m F_p}{1,000,000} = \text{(Horsepower to move the material)}$$

$$\text{Total HP} = \frac{(HP_f + HP_m) F_o}{e}$$

The following factors determine the horsepower requirement of a screw conveyor operating under the foregoing conditions.

- L = Total length of conveyor, feet
- N = Operating speed, RPM (revolutions per minute)
- F_d = Conveyor diameter factor (See Table 1-12)
- F_b = Hanger bearing factor (See Table 1-13)
- C = Capacity in cubic feet per hour
- W = Weight of material, lbs. per cubic foot
- F_f = Flight factor (See Table 1-14)
- F_m = Material factor (See Table 1-2)
- F_p = Paddle factor, when required. (See Table 1-15)
- F_o = Overload factor (See Table 1-16)
- e = Drive efficiency (See Table 1-17)

Table 1-12

Conveyor Diameter Factor, F_d	
Screw Diameter (Inches)	Factor F_d
4	12.0
6	18.0
9	31.0
10	37.0
12	55.0
14	78.0
16	106.0
18	135.0
20	165.0
24	235.0
30	365.0
36	540.0

Table 1-13

Hanger Bearing Selection		
Bearing Types		Hanger Bearing F_b
B	Ball	1.0
L	<i>Martin</i> Bronze	2.0
	* Graphite Bronze	
	* Oil Impregnated Bronze	
	* Oil Impregnated Wood	
	* Nylatron	
	* Nylon	
	* Teflon	
	* UHMW	
	* Melamine (MCB)	
	* Ertalyte® Quadrent	
	* Urethane	
	* <i>Martin</i> Hard Iron*	3.4
H	* Hard Iron	4.4
	* Stellite	
	* Ceramic	
	* White Iron Alloy	

* Non lubricated bearings, or bearings not additionally lubricated.

Horsepower Factor Tables



Table 1-14

Flight Factor F_f				
Flight Type	F_f Factor for Percent Conveyor Loading			
	15%	30%	45%	95%
Standard	1.0	1.0	1.0	1.0
Cut Flight	1.10	1.15	1.20	1.3
Cut & Folded Flight	N.R.*	1.50	1.70	2.20
Ribbon Flight	1.05	1.14	1.20	—

*Not Recommended

Table 1-15

Paddle Factor F_p					
Standard Paddles per Pitch, Paddles Set at 45° Reverse Pitch					
Number of Paddles per Pitch	0	1	2	3	4
Paddle Factor – F_p	1.0	1.29	1.58	1.87	2.16

Table 1-16

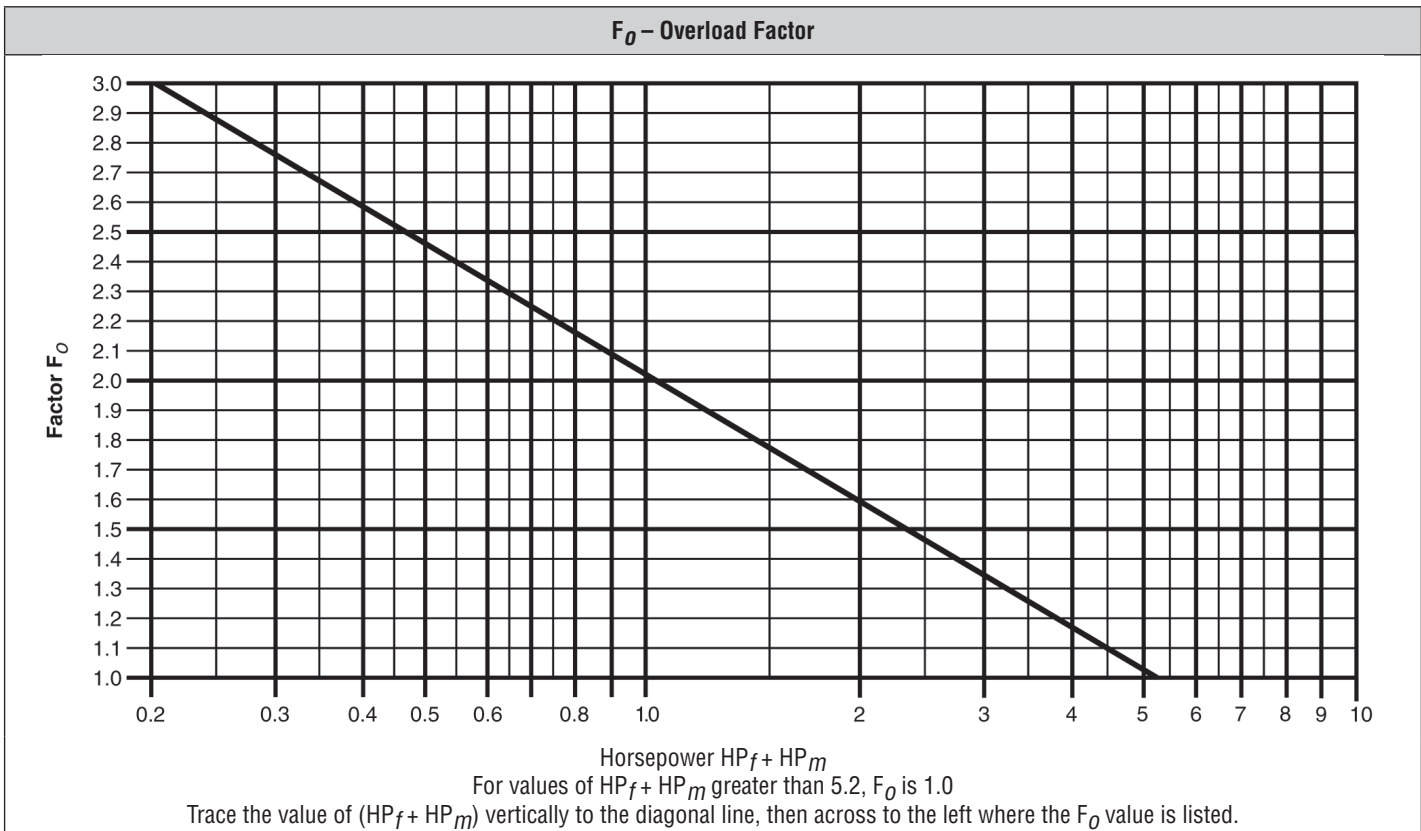

Table 1-17

e Drive Efficiency Factor				
Screw Drive or Shaft Mount w/V-Belt Drive	V-Belt to Helical Gear and Coupling	Gearmotor w/ Coupling	Gearmotor w/ Chain Drive	Worm Gear
.88	.87	.95	.87	Consult Manufacturer

EXAMPLE: Horsepower Calculation (See page H-180 for sample worksheet)

PROBLEM: Convey 1,000 cubic feet per hour Brewers grain, spent wet, in a 25'-0" long conveyor driven by a screw conveyor drive with V-belts.

SOLUTION:

1. Refer to material characteristic table 1-2 for Brewers grain, spent wet and find:

A. wt/cf: 55 - 60

B. Material code: C1/2 - 45T

Refer to Table 1-1, material classification code chart where:

C1/2 = Fine 1/2" and under

4 = Sluggish

5 = Mildly abrasive

T = Mildly corrosive

C. Intermediate bearing selection: L or S

Refer to Table 1-11 Bearing Selection, Find:

L = Bronze

S = Nylatron, Nylon, Teflon, UHMW Melamine, Graphite Bronze, Oil-impreg. Bronze, and oil-impreg. wood and Urethane.

D. Material Factor: $F_m = .8$

E. Trough Loading: 30%A

Refer to Table 1-6 capacity table and find 30%A which shows the various capacities per RPM of the standard size screw conveyors and the maximum RPM's for those sizes.

2. From Table 1-6, Capacity table under 30%A note that a 12" screw will convey 1,160 cubic feet per hour at 90 RPM maximum, therefore at 1 RPM a 12" screw will convey 12.9 cubic feet. For 1,000 CFH capacity at 12.9 CFH per RPM, the conveyor must therefore run 78RPM ($1000 \div 12.9 = 77.52$).

3. With the above information and factors from Tables 1-12 through 1-17 refer to the horsepower formulas on H-24 and calculate the required horsepower to convey 1000 CF/H for 25 feet in a 12" conveyor.

Using the known factors find that:

$L = 25'$

$N = 78$ RPM from step 2 above

$F_d = 55$ see Table 1-12, for 12"

$F_b = 2.0$ see Table 1-13 for L

$e = .88$ see Table 1-17

$C = 1000$ CFH

$W = 60\#/CF$ from step 1A

$F_f = 1$ see Table 1-14, standard 30%

$F_p = 1$ see Table 1-15

4. Solve the following horsepower equations:

$$A. HP_f = \frac{L N F_d F_b}{1,000,000} = \frac{25 \times 78 \times 55 \times 2.0}{1,000,000} = 0.215$$

$$B. HP_m = \frac{C L W F_f F_m F_p}{1,000,000} = \frac{1000 \times 25 \times 60 \times 1 \times .8 \times 1}{1,000,000} = 1.2$$

Find the F_o factor from 1-16; by adding HP_f and HP_m and matching this sum to the values on the chart.

$$C. HP_f = \frac{(HP_f + HP_m) (F_o)}{e} = \frac{(1.414) (1.9)}{.88} = 3.05$$

SOLUTION: 3.05 Horsepower is required to convey 1,000 CFH Brewers grain, spent wet in a 12" conveyor for 25 feet. A 5 H.P. motor should be used.

Torsional Ratings of Conveyor Screw Parts



Screw conveyors are limited in overall design by the amount of torque that can be safely transmitted through the pipes, couplings, and coupling bolts.

The table below combines the various torsional ratings of bolts, couplings and pipes so that it is easy to compare the torsional ratings of all the stressed parts of standard conveyor screws.

Table 1-18

Shaft Dia. In.	Pipe		Couplings		Dia. In.	Bolts in Shear In. Lbs. ▲		Bolts in Bearing In. Lbs.	
	Size In.	Torque In. Lbs.	Torque In. Lbs. *			No. of Bolts Used		No. of Bolts Used	
			C 1018	C 1045		2	3	2	3
1	1 1/4	3,140	820	1,025	3/8	1,380	2,070	1,970	2,955
1 1/2	2	7,500	3,070	3,850	1/2	3,660	5,490	5,000	7,500
2	2 1/2	14,250	7,600	9,500	5/8	7,600	11,400	7,860	11,790
2 7/16	3	23,100	15,030	18,780	5/8	9,270	13,900	11,640	17,460
3	3 1/2	32,100	28,350	35,440	3/4	16,400	24,600	15,540	23,310
3	4	43,000	28,350	35,440	3/4	16,400	24,600	25,000	37,500
3 7/16	4	43,300	42,470	53,080	7/8	25,600	38,400	21,800	32,700
3 15/16	5	65,100	61,190	76,485	1 1/8	48,540	72,810	52,120	78,180
4 7/16	6	101,160	88,212	110,265	1 1/4	67,520	101,280	90,750	136,125

▲ Values shown are for A307 64, Grade 2 Bolts. Values for Grade 5 Bolts are above × 2.5.

* Values are for unheattreated shafts.

The lowest torsional rating figure for any given component will be the one that governs how much torque may be safely transmitted. For example, using standard unhardened two bolt coupling shafts, the limiting torsional strength of each part is indicated in Table 1-18.

Thus it can be seen that the shaft itself is the limiting factor on 1", 1 1/2" and 2" couplings. The bolts in shear are the limiting factors on the 2-7/16" coupling and on the 3" coupling used in conjunction with 4" pipe. The bolts in bearing are the limiting factors for the 3" coupling used in conjunction with 3 1/2" pipe, and for the 3-7/16" coupling.

FORMULA: Horsepower To Torque (In. Lbs.)

$$\frac{63,025 \times \text{HP}}{\text{RPM}} = \text{Torque (In. Lbs.)}$$

EXAMPLE: 12" Screw, 78 RPM, 5 Horsepower

$$\frac{63,025 \times 5}{78} = 4,040 \text{ In. Lbs.}$$

From the table above 2" shafts with 2 bolt drilling and 2 1/2" std. pipe are adequate (4,040 < 7600).

If the torque is greater than the values in the above table, such as in 2" couplings (torque > 7600), then hardened shafts can be used as long as the torque is less than the value for hardened couplings (torque < 9500). If the torque is greater than the 2 bolt in shear value but less than the 3 bolt in shear value then 3 bolt coupling can be used. The same applies with bolts in bearing. When the transmitted torque is greater than the pipe size value, then larger pipe or heavier wall pipe may be used. Other solutions include: high torque bolts to increase bolt in shear rating, external collars, or bolt pads welded to pipe to increase bolt in bearing transmission. For solutions other than those outlined in the above table please consult our Engineering Department.

Screw conveyors are limited in overall design by the amount of horsepower that can be safely transmitted through the pipes, couplings, and coupling bolts.

The table below combines the various horsepower ratings of bolts, couplings and pipes so that it is easy to compare the ratings of all the stressed parts of standard conveyor screws.

Table 1-19

Coupling Shaft Dia. In.	Pipe		Coupling		Bolt Dia. In.	Bolts			
	Size In.	H.P. per R.P.M.	H.P. per R.P.M			Bolts in Shear H.P. per R.P.M. ▲		Bolts in Bearing H.P. per R.P.M.	
			CEMA Std (C-1018)	Martin Std. (C-1045)		No. of Bolts Used		No. of Bolts Used	
						2	3	2	3
1	1 1/4	.049	.013	.016	3/8	.021	.032	.031	.046
1 1/2	2	.119	.048	.058	1/2	.058	.087	.079	.119
2	2 1/2	.226	.120	.146	5/8	.120	.180	.124	.187
2 7/16	3	.366	.239	.289	5/8	.147	.220	.184	.277
3	3 1/2	.509	.450	.546	3/4	.260	.390	.246	.369
3	4	.682	.450	.546	3/4	.260	.390	.396	.595
3 7/16	4	.682	.675	.818	7/8	.406	.609	.345	.518
3	3 1/2	.509	.450	.546	3/4	.260	.390	.246	.369

▲ Values shown are for A307 64, Grade 2 Bolts.

The lowest horsepower rating figure for any given component will be the one that governs how much horsepower may be safely transmitted. The limiting strength of each part is indicated by the underlined figures in the table above.

FORMULA: Horsepower To Horsepower @ 1 RPM)

EXAMPLE: 12" Screw, 78 RPM, 5 Horsepower
 $\frac{5 \text{ HP}}{78 \text{ RPM}} = 0.06 \text{ HP at 1 RPM}$

From the table above .038 is less than the lowest limiting factor for 2" couplings, so 2" standard couplings with 2 bolts may be used. Solutions to limitations are the same as shown on H-26.

Screw Conveyor End Thrust Thermal Expansion



End thrust in a Screw Conveyor is created as a reaction to the forces required to move the material along the axis of the conveyor trough. Such a force is opposite in direction to the flow of material. A thrust bearing and sometimes reinforcement of the conveyor trough is required to resist thrust forces. Best performance can be expected if the conveyor end thrust bearing is placed so that the rotating members are in tension; therefore, an end thrust bearing should be placed at the discharge end of a conveyor. Placing an end thrust bearing assembly at the feed end of a conveyor places rotating members in compression which may have undesirable effects, but this is sometimes necessary in locating equipment.

There are several methods of absorbing thrust forces, the most popular methods are:

1. Thrust washer assembly — installed on the shaft between the pipe end and the trough end plate, or on the outside of the end bearing.
2. Type “E” end thrust assembly, which is a Double Roller Bearing and shaft assembly.
3. Screw Conveyor Drive Unit, equipped with double roller bearing thrust bearings, to carry both thrust and radial loads.

Past experience has established that component selection to withstand end thrust is rarely a critical factor and thrust is not normally calculated for design purposes. Standard conveyor thrust components will absorb thrust without resorting to special design in most applications.

Expansion of Screw Conveyors Handling Hot Materials

Screw conveyors often are employed to convey hot materials. It is therefore necessary to recognize that the conveyor will increase in length as the temperature of the trough and screw increases when the hot material begins to be conveyed.

The recommended general practice is to provide supports for the trough which will allow movement of the trough end feet during the trough expansion, and during the subsequent contraction when handling of the hot material ceases. The drive end of the conveyor usually is fixed, allowing the remainder of the trough to expand or contract. In the event there are intermediate inlets or discharge spouts that cannot move, the expansion type troughs are required.

Furthermore, the conveyor screw may expand or contract in length at different rates than the trough. Therefore, expansion hangers are generally recommended. The trough end opposite the drive should incorporate an expansion type ball or roller bearing or sleeve bearing which will safely provide sufficient movement.

The change in screw conveyor length may be determined from the following formula:

$$\Delta L = L (t_1 - t_2) C$$

Where: ΔL = increment of change in length, inch

L = overall conveyor length in inches

t_1 = upper limit of temperature, degrees Fahrenheit

t_2 = limit of temperature, degrees Fahrenheit (or lowest ambient temperature expected)

C = coefficient of linear expansion, inches per inch per degree Fahrenheit. This coefficient has the following values for various metals:

a) Hot rolled carbon steel, 6.5×10^{-6} , (.0000065)

b) Stainless steel, 9.9×10^{-6} , (.0000099)

c) Aluminum, 12.8×10^{-6} , (.0000128)

EXAMPLE: A carbon steel screw conveyor 30 feet overall length is subject to a rise in temperature of 200°F, reaching a hot metal temperature of 260°F from an original metal temperature of 60°F.

$$t_1 = 260 \quad t_1 - t_2 = 200$$

$$t_2 = 60$$

$$L = (30) (12) = 360$$

$$\Delta L = (360) (200) (6.5 \times 10^{-6})$$

$$= 0.468 \text{ inches, or about } 15/32 \text{ inches.}$$

When using conveyor screws of standard length, deflection is seldom a problem. However, if longer than standard sections of screw are to be used, without intermediate hanger bearings, care should be taken to prevent the screw flights from contacting the trough because of excessive deflection. The deflection at mid span may be calculated from the following formula.

$$D = \frac{5WL^3}{384 (29,000,000) (I)}$$

Where: D = Deflection at mid span in inches
 W = Total screw weight in pounds, see pages H-79 to H-84
 L = Screw length in inches
 I = Movement of inertia of pipe or shaft, see table 1-20 or 1-21 below

Table 1-20

Schedule 40 Pipe									
Pipe Size	2"	2 1/2"	3"	3 1/2"	4"	5"	6"	8"	10"
I	.666	1.53	3.02	4.79	7.23	15.2	28.1	72.5	161

Table 1-21

Schedule 80 Pipe									
Pipe Size	2"	2 1/2"	3"	3 1/2"	4"	5"	6"	8"	10"
I	.868	1.92	3.89	6.28	9.61	20.7	40.5	106	212

EXAMPLE: Determine the deflection of a 12H512 screw conveyor section mounted on 3" sch 40 pipe, overall length is 16'-0".

W = 272#

L = 192"

I = 3.02 (From chart above)

$$D = \frac{5(272\#)(192^3)}{384 (29,000,000) (3.02)} = .29 \text{ inches}$$

Applications where the calculated deflection of the screw exceeds .25 inches (1/4") should be referred to our Engineering Department for recommendations. Very often the problem of deflection can be solved by using a conveyor screw section with a larger diameter pipe or a heavier wall pipe. Usually, larger pipe sizes tend to reduce deflection more effectively than heavier wall pipe.

Conveyor Screw Deflection

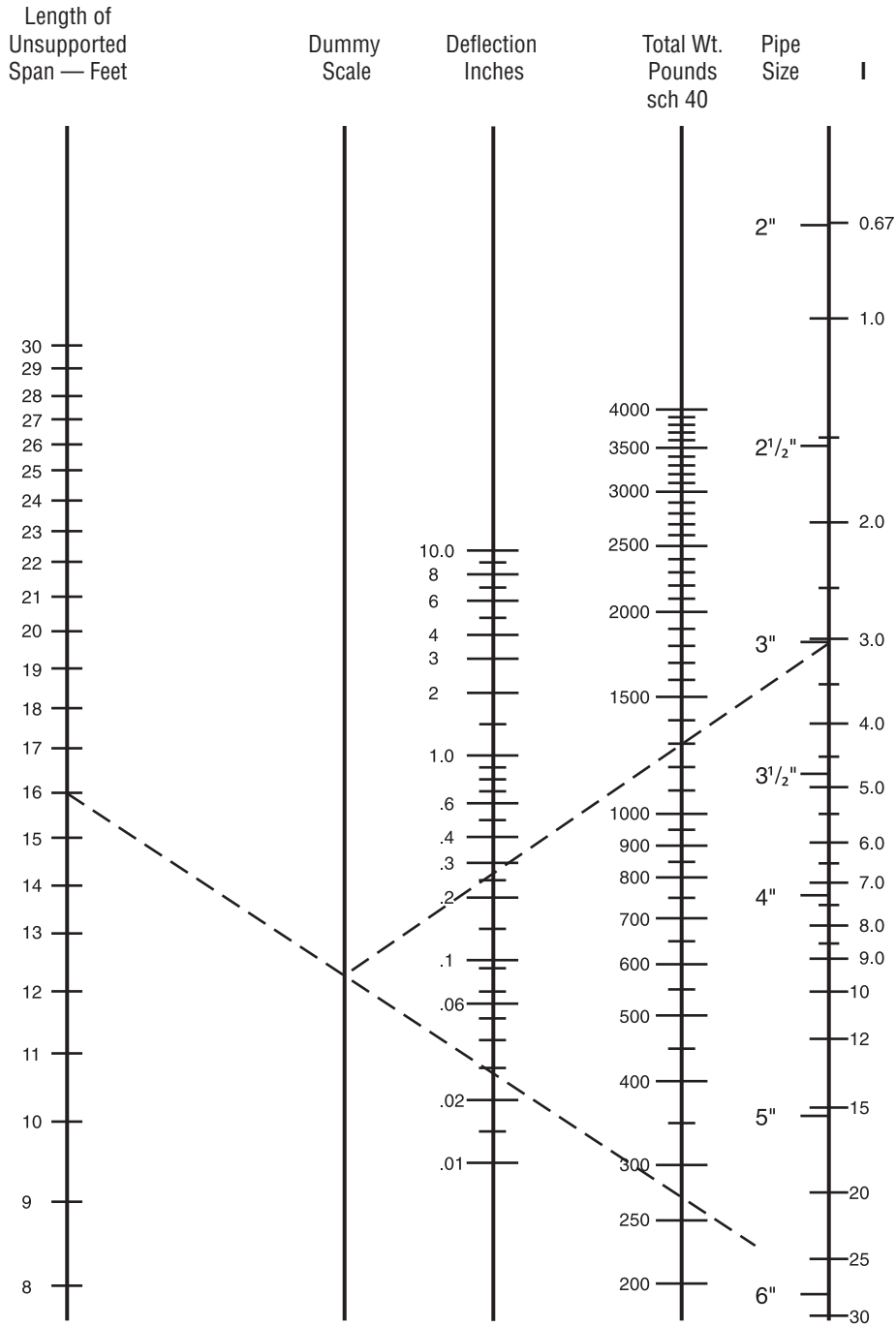

I = Moment of inertia of pipe or shaft, see Table 1-20 or 1-21

The above Nomograph can be used for a quick reference to check deflection of most conveyors.

Inclined Screw Conveyors

Inclined screw conveyors have a greater horsepower requirement and a lower capacity rating than horizontal conveyors. The amounts of horsepower increase and capacity loss depend upon the angle of incline and the characteristics of the material conveyed.

Inclined conveyors operate most efficiently when they are of tubular or shrouded cover design, and a minimum number of intermediate hanger bearings. Where possible, they should be operated at relatively high speeds to help prevent fallback of the conveyed material.

Consult our Engineering Department for design recommendations and horsepower requirements for your particular application.

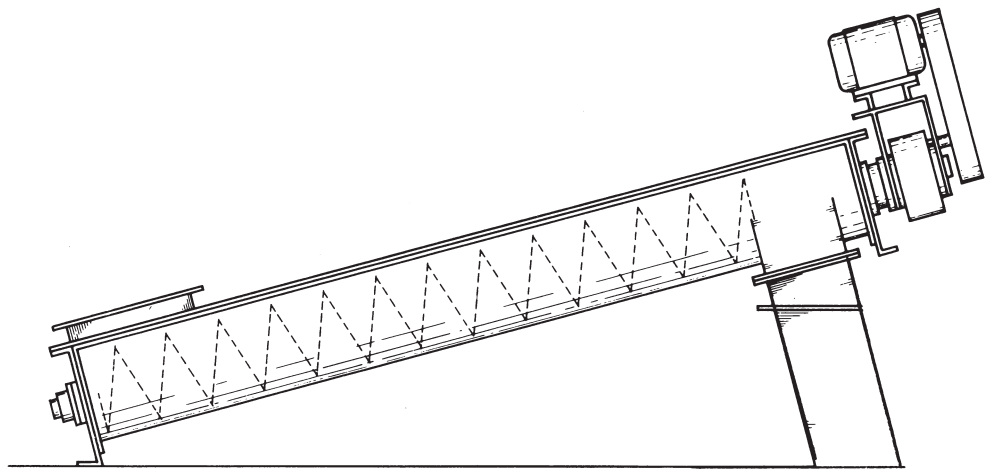

Vertical Screw Conveyors

Vertical screw conveyors provide an efficient method of elevating most materials that can be conveyed in horizontal screw conveyors. Since vertical conveyors must be uniformly loaded in order to prevent choking, they are usually designed with integral feeders.

As with horizontal conveyors, vertical screw conveyors are available with many special features and accessories, including components of stainless steel or other alloys.

Consult our Engineering Department for design recommendations and horsepower requirements for your particular application.

SEE VERTICAL SCREW CONVEYOR SECTION OF CATALOG FOR ADDITIONAL INFORMATION.

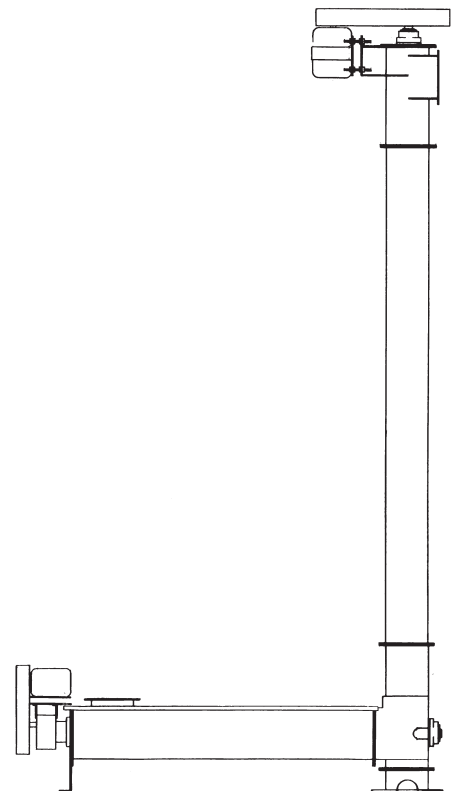

Screw Feeders



Screw Feeders are designed to regulate the rate of material flow from a hopper or bin. The inlet is usually flooded with material (95% loaded). One or more tapered or variable pitch screws convey the material at the required rate. Screw feeders are regularly provided with shrouded or curved cover plates for a short distance beyond the end of the inlet opening, to obtain feed regulation. As the pitch or diameter increases beyond the shroud the level of the material in the conveyor drops to normal loading levels. Longer shrouds, extra short pitch screws and other modifications are occasionally required to reduce flushing of very free flowing material along the feeder screw.

Feeders are made in two general types: Type 1 with regular pitch flighting and Type 2 with short pitch flighting. Both types are also available with uniform diameter and tapering diameter screws. The various combinations are shown on pages H-33 – H-34. Screw feeders with uniform screws, Types 1B, 1D, 2B, 2D are regularly used for handling fine free flowing materials. Since the diameter of the screw is uniform, the feed of the material will be from the forepart of the inlet and not across the entire length. Where hoppers, bins, tanks, etc. are to be completely emptied, or dead areas of material over the inlet are not objectionable, this type of feeder is entirely satisfactory, as well as economical. Screw feeders with tapering diameter screws will readily handle materials containing a fair percentage of lumps. In addition, they are used extensively where it is necessary or desirable to draw the material uniformly across the entire length of the inlet opening to eliminate inert or dead areas of material at the forepart of the opening. Types 1A, 1C, 2A, and 2C fall into this category. Variable pitch screws can be used in place of tapering diameter screws for some applications. They consist of screws with succeeding sectional flights increasing progressively in pitch. The portion of the screw with the smaller pitch is located under the inlet opening.

Screw feeders with extended screw conveyors are necessary when intermediate hangers are required, or when it is necessary to convey the material for some distance. A screw conveyor of larger diameter than the feeder screw is combined with the feeder to make the extension. See types 1C, 1D, 2C, 2D.

Multiple screw feeders are usually in flat bottom bins for discharging material which have a tendency to pack or bridge under pressure. Frequently, the entire bin bottom is provided with these feeders which convey the material to collecting conveyors. Such arrangements are commonly used for handling hogged fuel, wood shavings, etc.

Screw feeders are available in a variety of types to suit specific materials and applications. We recommend that you contact our Engineering Department for design information.

Typical Type 1

Feeder Type	Inlet Opening	Material Removal	Pitch	Feeder Screw Diameter	Extended Screw
SF1A	Standard	Uniform Full Length of Inlet Opening	Standard	Tapered	None
SF1B	Standard	Forepart Only of Inlet Opening	Standard	Uniform	None
SF1C	Standard	Uniform Full Length of Inlet Opening	Standard	Tapered	As Required
SF1D	Standard	Forepart Only of Inlet Opening	Standard	Uniform	As Required

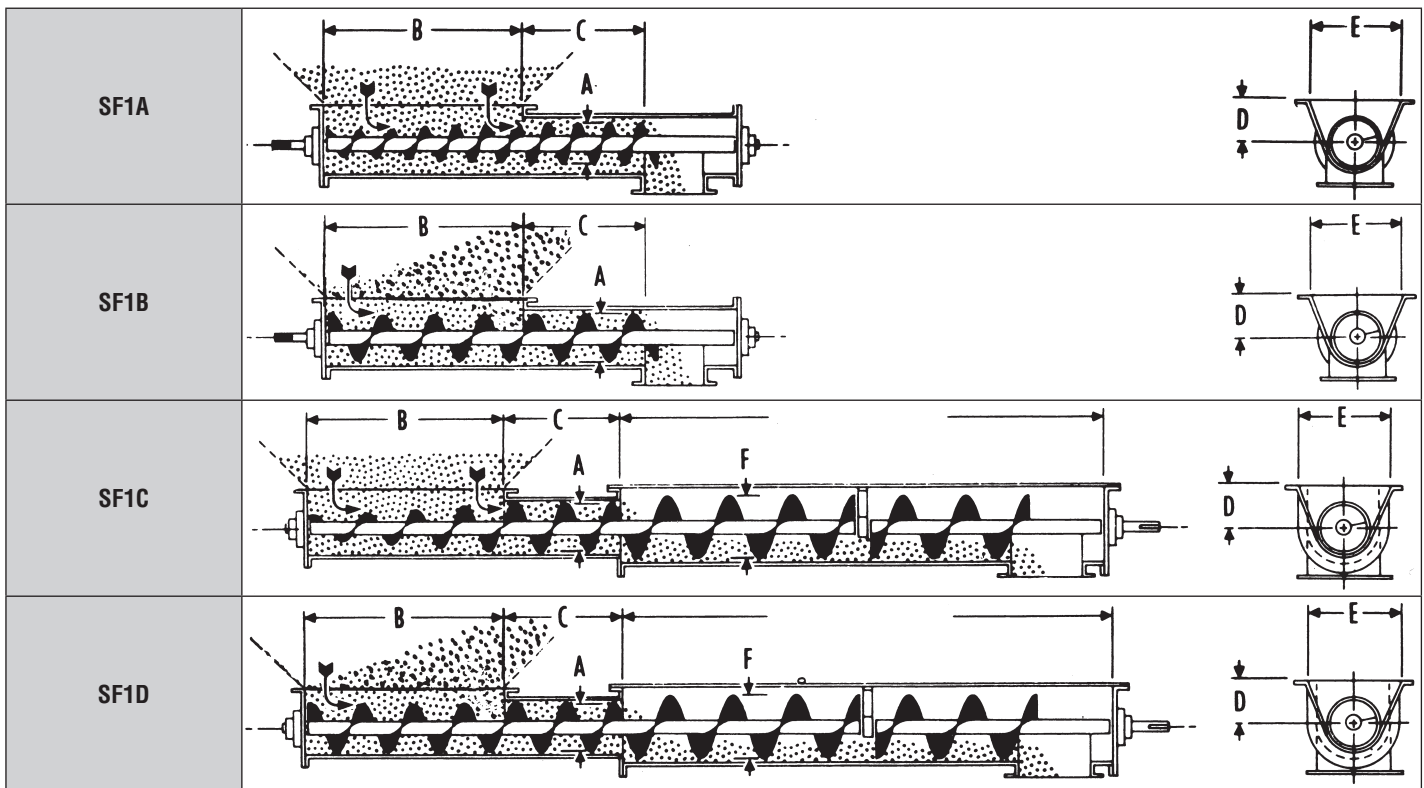

Feeder Diameter A	Maximum Lump Size	Maximum Speed RPM	Capacity Cubic Feet per Hour		B*	C	D	E	Extended Screw Diameter F		
			At One RPM	At Maximum RPM					Trough Loading %		
									15	30	45
6	3/4"	70	4.8	336	36	12	7	14	12	9	9
9	1 1/2"	65	17	1105	42	18	9	18	18	14	12
12	2"	60	44	2640	48	24	10	22	24	18	16
14	2 1/2"	55	68	3740	54	28	11	24		20	18
16	3"	50	104	5200	56	32	11 1/2	28		24	20
18	3"	45	150	6750	58	36	12 1/8	31			24
20	3 1/2"	40	208	8320	60	40	13 1/2	34			
24	4"	30	340	10200	64	48	16 1/2	40			

* Consult factory if inlet exceeds these lengths.

Screw Feeders

(For Inclined Applications Consult Factory)



Typical Type 2

Feeder Type	Inlet Opening	Material Removal	Pitch	Feeder Screw Diameter	Extended Screw
SF2A	Long	Uniform Full Length of Inlet Opening	Short (2/3)	Tapered	None
SF2B	Long	Forepart Only of Inlet Opening	Short (2/3)	Uniform	None
SF2C	Long	Uniform Full Length of Inlet Opening	Short (2/3)	Tapered	As Required
SF2D	Long	Forepart Only of Inlet Opening	Short (2/3)	Uniform	As Required

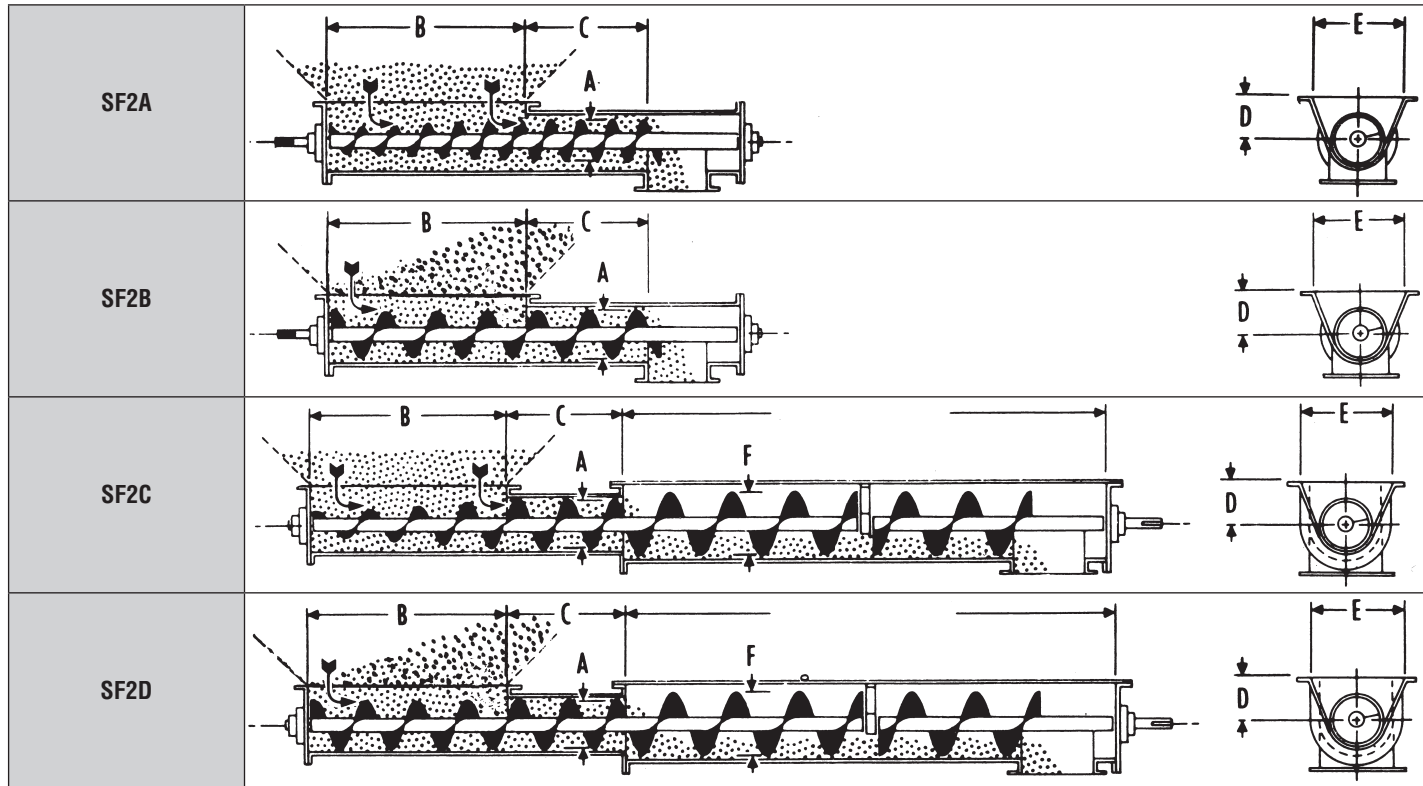

Feeder Diameter A	Maximum Lump Size	Maximum Speed RPM	Capacity Cubic Feet per Hour		B*	C	D	E	Extended Screw Diameter F		
			At One RPM	At Maximum RPM					Trough Loading %		
									15	30	45
6	1/2"	70	3.1	217	60	18	7	14	10	9	9
9	3/4"	65	11	715	66	27	9	18	14	12	10
12	1"	60	29	1740	72	36	10	22	20	16	14
14	1 1/4"	55	44	2420	76	42	11	24	24	18	16
16	1 1/2"	50	68	3400	78	48	11 1/2	28	20	18	20
18	1 3/4"	45	99	4455	80	54	12 1/8	31	24	20	24
20	2"	40	137	5480	82	60	13 1/2	34	24		
24	2 1/2"	30	224	6720	86	72	16 1/2	40			

	PAGE
CLASSIFICATION OF ENCLOSURE TYPES	H-36
HAND OF CONVEYORS	H-37
CLASSIFICATION OF SPECIAL CONTINUOUS WELD FINISHES	H-38
DETAILING OF "U" TROUGH	H-39
DETAILING OF TUBULAR TROUGH	H-40
DETAILING OF TROUGH AND DISCHARGE FLANGES	H-41
BOLT TABLES	H-43
PIPE SIZES AND WEIGHTS	H-45
SCREW CONVEYOR DRIVE ARRANGEMENTS	H-46
STANDARDS HELICOID SCREW	H-47
STANDARDS SECTIONAL (BUTTWELD) SCREW	H-48
SCREW CONVEYOR SAMPLE HORSEPOWER WORKSHEET	H-184

Classes of Enclosures

Conveyors can be designed to protect the material being handled from a hazardous surrounding or to protect the surroundings from a hazardous material being conveyed.

This section establishes recommended classes of construction for conveyor enclosures — without regard to their end use or application. These several classes call for specific things to be done to a standard conveyor housing to provide several degrees of enclosure protection.

Enclosure Classifications

- Class IE — Class IE enclosures are those provided primarily for the protection of operating personnel or equipment, or where the enclosure forms an integral or functional part of the conveyor or structure. They are generally used where dust control is not a factor or where protection for, or against, the material being handled is not necessary — although as conveyor enclosures a certain amount of protection is afforded.
- Class IIE — Class IIE enclosures employ constructions which provide some measure of protection against dust or for, or against, the material being handled.
- Class IIIE — Class IIIE enclosures employ constructions which provide a higher degree of protection in these classes against dust, and for or against the material being handled.
- Class IVE — Class IVE enclosures are for outdoor applications and under normal circumstances provide for the exclusion of water from the inside of the casing. They are not to be construed as being water-tight, as this may not always be the case.

When more than one method of fabrication is shown, either is acceptable.

Enclosures



Enclosure Construction				
Component Classification	Enclosure Classifications			
	I E	II E	III E	IV E
A. TROUGH CONSTRUCTION				
Formed & Angle Top Flange				
1. Plate type end flange				
a. Continuous arc weld	X	X	X	X
b. Continuous arc weld on top of end flange and trough top rail	X	X	X	X
2. Trough Top Rail Angles (Angle Top trough only)				
a. Staggered intermittent arc and spot weld	X			
b. Continuous arc weld on top leg of angle on inside of trough and intermittent arc weld on lower leg of angle to outside of trough		X	X	X
c. Staggered intermittent arc weld on top leg of angle on inside of trough and intermittent arc weld on lower leg of angle to outside of trough, or spot weld when mastic is used between leg of angle and trough sheet		X	X	X
B. COVER CONSTRUCTION				
1. Plain flat				
a. Only butted when hanger is at cover joint	X			
b. Lapped when hanger is not at cover joint	X			
2. Semi-Flanged				
a. Only butted when hanger is at cover joint	X	X	X	X
b. Lapped when hanger is not at cover joint	X			
c. With buttstrap when hanger is not at cover joint		X	X	X
3. Flanged				
a. Only butted when hanger is at cover joint		X	X	X
b. Buttstrap when hanger is not at cover joint		X	X	X
4. Hip Roof				
a. Ends with a buttstrap connection				X
C. COVER FASTENERS FOR STANDARD GA. COVERS				
1. Spring, screw or toggle clamp fasteners or bolted construction				
a. Max. spacing plain flat covers	60"			
b. Max. spacing semi-flanged covers	60"	30"	18"	18"
c. Max. spacing flanged and hip-roof covers		40"	24"	24"
D. GASKETS				
1. Covers				
a. Red rubber or felt up to 230° F		X	X	
b. Neoprene rubber, when contamination is a problem		X	X	
c. Closed cell foam type elastic material to suit temperature rating of gasket		X	X	X
2. Trough End flanges				
a. Mastic type compounds		X	X	X
b. Red rubber up to 230° F		X	X	X
c. Neoprene rubber, when contamination is a problem		X	X	
d. Closed cell foam type elastic material to suit temperature rating of gasket		X	X	X
E. TROUGH END SHAFT SEALS*				
1. When handling non-abrasive materials			X	X
2. When handling abrasive materials	X	X	X	X

- *NOTES:**
- Lip type seals for non-abrasive materials
 - Felt type for mildly abrasive materials
 - Waste type for highly abrasive materials
 - Waste type for moderately abrasive
 - Air-Purged *Martin* Super Pack for extremely abrasive
 - Bulk Heads may be required for abrasive & hot materials

WARNING: CHECK MATERIAL TEMPERATURE.

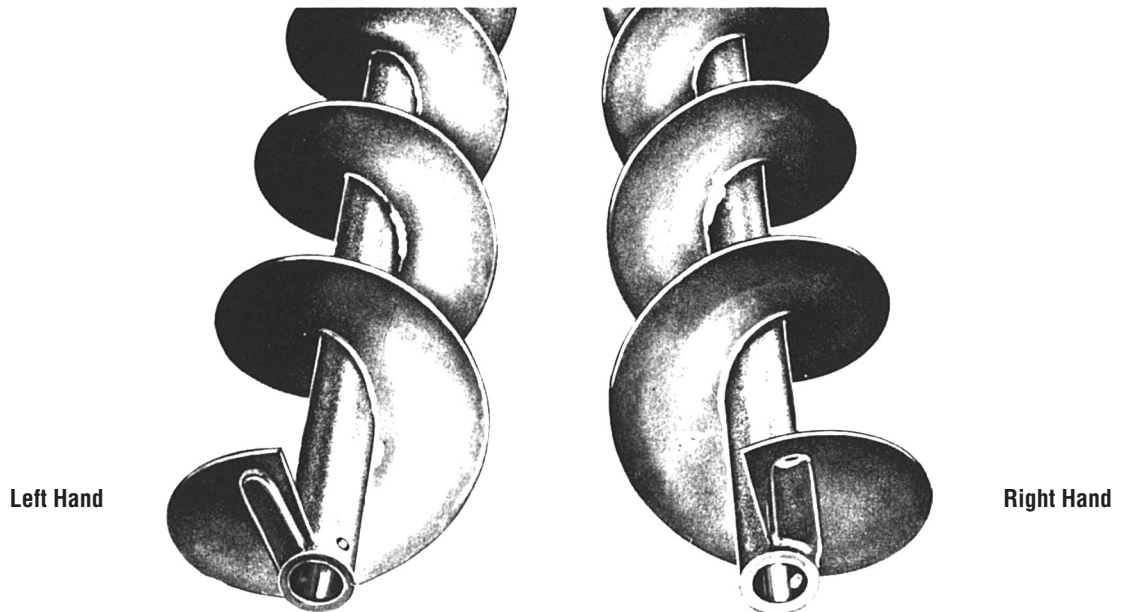

Right and Left Hand Screw

A conveyor screw is either right hand or left hand depending on the form of the helix. The hand of the screw is easily determined by looking at the end of the screw.

The screw pictured to the left has the flight helix wrapped around the pipe in a counter-clockwise direction, or to your left. Same as left hand threads on a bolt. This is arbitrarily termed a LEFT hand screw.

The screw pictured to the right has the flight helix wrapped around the pipe in a clockwise direction, or to your right. Same as right hand threads on a bolt. This is termed a RIGHT hand screw.

A conveyor screw viewed from either end will show the same configuration. If the end of the conveyor screw is not readily visible, then by merely imagining that the flighting has been cut, with the cut end exposed, the hand of the screw may be easily determined.

Conveyor Screw Rotation



The above diagrams are a simple means of determining screw rotation. When the material flow is in the direction away from the end being viewed, a R.H. screw will turn counter clockwise and a L.H. screw will turn clockwise rotation as shown by the arrows.

Conveyor Screw Rotation

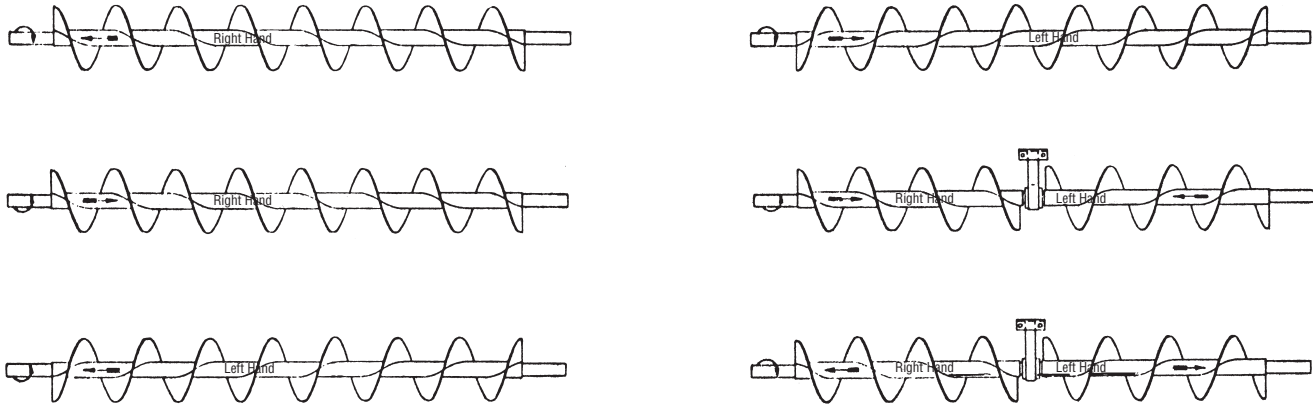

The above diagram indicates the hand of conveyor screw to use when direction of rotation and material flow are known.

Special Screw Conveyor Continuous Weld Finishes

Specifications on screw conveyor occasionally include the term “grind smooth” when referring to the finish on continuous welds. This specification is usually used for stainless steel, but occasionally it will appear in carbon steel specifications as well.

“Grind smooth” is a general term and subject to various interpretations. This Table establishes recommended classes of finishes, which should be used to help find the class required for an application.

Operation	Weld Finishes			
	I	II	III	IV
Weld spatter and slag removed	X	X	X	X
Rough grind welds to remove heavy weld ripple or unusual roughness (Equivalent to a 40-50 grit finish)		X		
Medium grind welds — leaving some pits and crevices (Equivalent to a 80-100 grit finish)			X	
Fine grind welds — no pits or crevices permissible (Equivalent to a 140-150 grit finish)				X

* *Martin* IV Finish: CEMA IV welds, polish pipe & flights to 140-150 grit finish.

* *Martin* IV Polish: Same as above plus Scotch-Brite Finish.

Trough

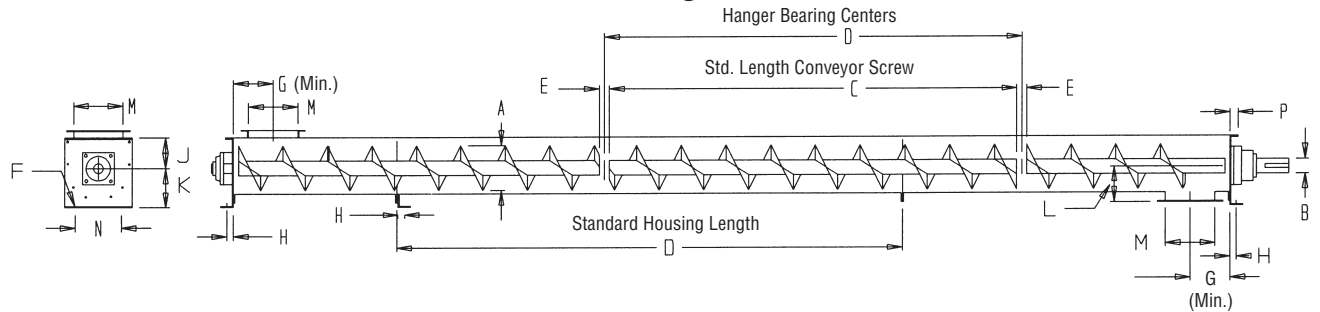

A Screw Dia.	B Coupling Dia.	C Length	D Length	E	F	G (Min.)	H	J	K	L	M	N	P	R
4	1	9 - 10 1/2	10	1 1/2	3/8	4 1/2	7/8	3 5/8	4 5/8	3 3/4	5	5 3/4	1 7/16	1
6	1 1/2	9 - 10	10	2	3/8	6	13/16	4 1/2	5 5/8	5	7	8 1/8	1 1/2	1
9	1 1/2 2	9 - 10	10	2	1/2	8	15/16	6 1/8	7 7/8	7 1/8	10	9 3/8	1 5/8	1 1/2
10	1 1/2 2	9 - 10	10	2	1/2	9	1 9/16	6 3/8	8 7/8	7 7/8	11	9 1/2	1 3/4	1 3/4
12	2 2 7/16 3	11 - 10 11 - 9 11 - 9	12	2 3 3	5/8	10 1/2	1 3/8	7 3/4	9 5/8	8 7/8	13	12 1/4	2	1 5/8
14	2 7/16 3	11 - 9	12	3	5/8	11 1/2	1 3/8	9 1/4	10 7/8	10 1/8	15	13 1/2	2	1 5/8
16	3	11 - 9	12	3	5/8	13 1/2	1 3/4	10 5/8	12	11 1/8	17	14 7/8	2 1/2	2
18	3 3 7/16	11 - 9 11 - 8	12	3 4	5/8	14 1/2	1 3/4	12 1/8	13 3/8	12 3/8	19	16	2 1/2	2
20	3 3 7/16	11 - 9 11 - 8	12	3 4	3/4	15 1/2	2	13 1/2	15	13 3/8	21	19 1/4	2 1/2	2 1/4
24	3 7/16	11 - 9	12	4	3/4	17 1/2	2 1/4	16 1/2	18 1/8	15 3/8	25	20	2 1/2	2 1/2

Screw clearance at trough end is one half of dimension E.

Typical Method of Detailing

9" x 2" x 25'-0" Conveyor

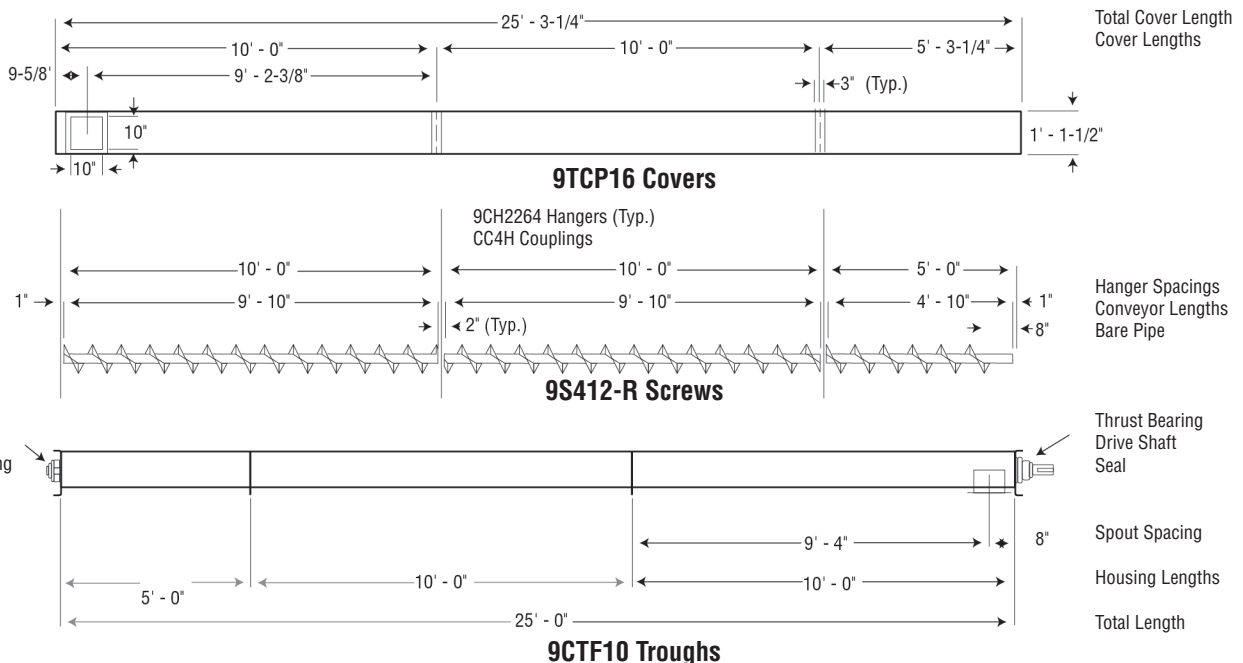

Tubular Housing

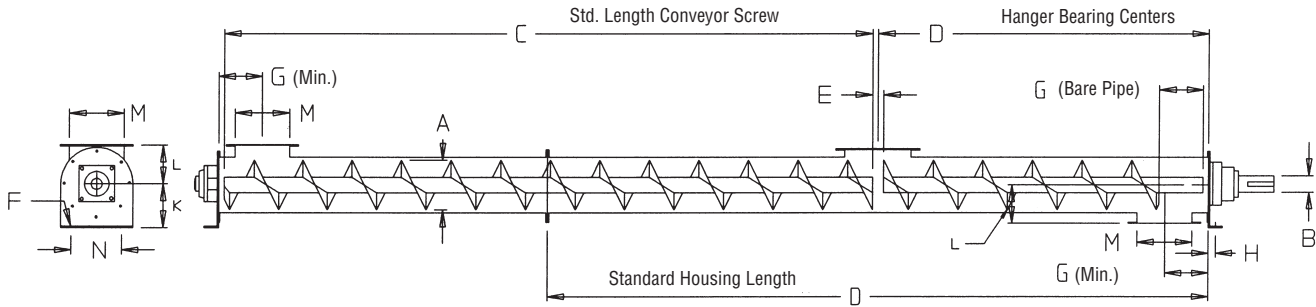

A Screw Dia.	B Coupling Dia.	C Length	D Length	E	F	G (Min.)	H	K	L	M	N	P	R
4	1	9 - 10 1/2	10	1 1/2	3/8	4 1/2	7/8	4 5/8	3 3/4	5	5 3/4	1 7/16	1
6	1 1/2	9 - 10	10	2	3/8	6	13/16	5 5/8	5	7	8 1/8	1 1/2	1
9	1 1/2 2	9 - 10 9 - 10	10	2	1/2	8	1 5/16	7 7/8	7 1/8	10	9 3/8	1 5/8	1 1/2
10	1 1/2 2	9 - 10 9 - 10	10	2	1/2	9	1 9/16	8 7/8	7 7/8	11	9 1/2	1 3/4	1 3/4
12	2 2 7/16 3	11 - 10 11 - 9 11 - 9	12	2 3 3	5/8	10 1/2	1 3/8	9 5/8	8 7/8	13	12 1/4	2	1 5/8
14	2 7/16 3	11 - 9 11 - 9	12	3	5/8	11 1/2	1 3/8	10 7/8	10 1/8	15	13 1/2	2	1 5/8
16	3	11 - 9	12	3	5/8	13 1/2	1 3/4	12	11 1/8	17	14 7/8	2 1/2	2
18	3 3 7/16	11 - 9 11 - 8	12	3 4	5/8 3/4	14 1/2 15 1/2	1 3/4 2	13 3/8 15	12 3/8 13 3/8	19 21	16 19 1/4	2 1/2 2 1/2	2 2 1/4
20	3 3 7/16	11 - 9 11 8	12	3 4	3/4	15 1/2	2	15	13 3/8	21	19 1/4	2 1/2	2 1/4
24	3 7/16	11 8	12	4	3/4	17 1/2	2 1/4	18 1/8	15 3/8	25	20	2 1/2	2 1/2

Screw clearance at trough end is one half of dimension E.

Typical Method of Detailing

9" x 2" x 25'-0" Conveyor

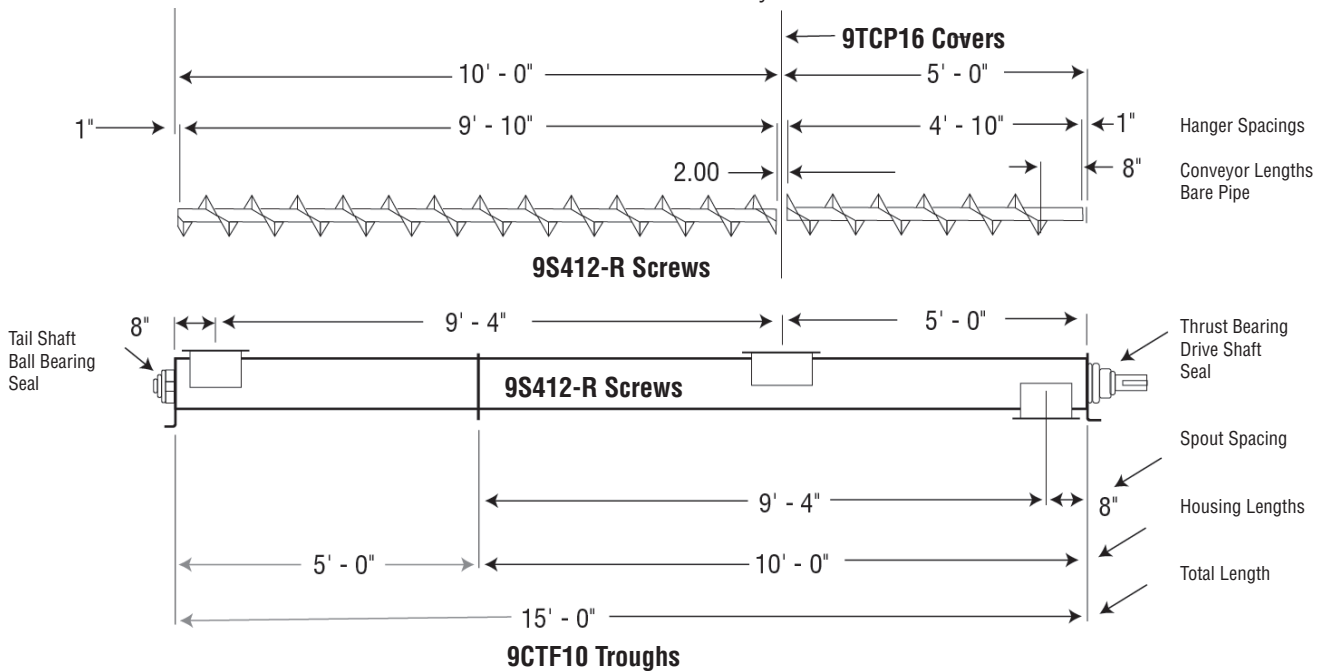

U-Trough End Flanges

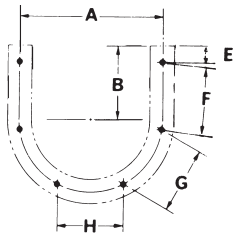

6 Bolts

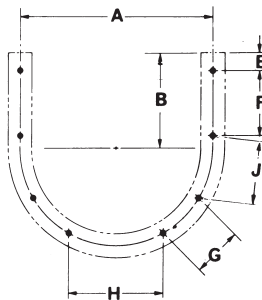

8 Bolts

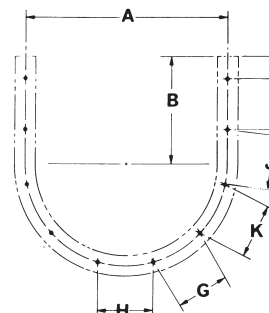

10 Bolts

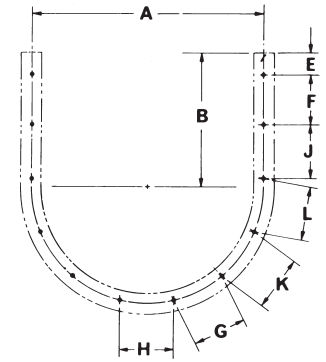

12 Bolts

Screw Diameter	Bolts		A	B	E	F	G	H	J	K	L
	Number	Diameter									
4	6	3/8	7	3 5/8	1 1/8	3 1/8	3 1/8	3 1/8	X	X	X
6	6	3/8	8 7/8	4 1/2	1 1/32	4 1/8	4 1/16	4 1/16	X	X	X
9	8	3/8	12 1/2	6 1/8	1 3/16	4 1/8	3 3/4	5 1/8	4 1/8	X	X
10	8	3/8	13 1/4	6 3/8	2 1/4	3 1/2	4 3/16	5 1/16	4 1/8	X	X
12	8	1/2	15 7/8	7 3/4	1 1/2	5 5/16	4 1/16	7 3/4	5 3/16	X	X
14	8	1/2	17 7/8	9 1/4	2 17/32	5 5/8	5 15/16	6	5 15/16	X	X
16	8	5/8	20	10 5/8	2 5/8	6 3/8	6 5/8	7 1/2	6 5/8	X	X
18	10	5/8	22	12 1/8	2 23/32	5 15/16	5 7/8	5 7/8	5 7/8	5 7/8	X
20	10	5/8	24 3/8	13 1/2	2 25/32	6 1/4	6 11/16	6 11/16	6 11/16	6 11/16	X
24	12	5/8	28 1/2	16 1/2	2 25/32	6 1/8	6 5/8	6 5/8	6 5/8	6 5/8	6 5/8

Flared Trough End Flanges

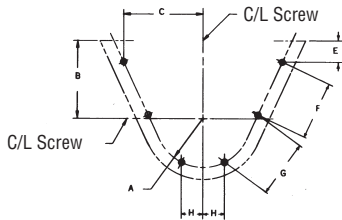

6 Bolts

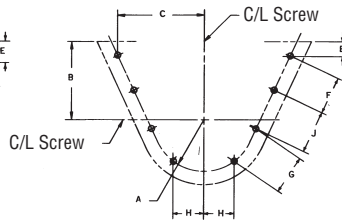

8 Bolts

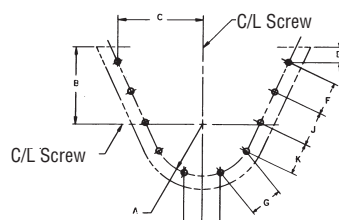

10 Bolts

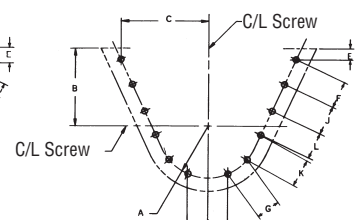

12 Bolts

Screw Diameter	Bolts		A	B	C	E	F	G	H	J	K	L
	Diameter Number	Holes										
6	3/8	6	4 7/16	7	7 3/16	1 27/32	5 1/4	5 1/4	2 1/32	—	—	—
9	3/8	8	6 1/4	9	9 21/32	1 43/64	5	5	2 9/16	5	—	—
12	1/2	8	7 15/16	10	11 13/16	1 13/16	5 3/4	5 3/4	3 7/8	5 3/4	—	—
14	1/2	10	8 15/16	11	12 49/64	2 1/16	5 1/8	5 1/8	3	5 1/8	5 1/8	—
16	5/8	10	10	11 1/2	14 11/16	2 15/64	5 1/2	5 1/2	3 3/4	5 1/2	5 1/2	—
18	5/8	10	11	12 1/8	16	2 5/8	6 3/16	6 3/16	2 15/16	6 3/16	6 3/16	—
20	5/8	10	12 3/16	13 1/2	17 7/8	2 9/32	7	7	3 11/32	7	7	—
24	5/8	12	14 1/4	16 1/2	20 61/64	2 5/16	6 7/8	6 7/8	3 5/16	6 7/8	6 7/8	6 7/8



Tubular Housing Flanges

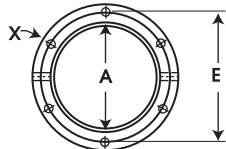

6 Bolts

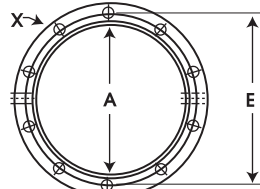

10 Bolts

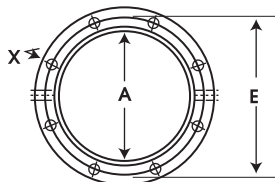

8 Bolts

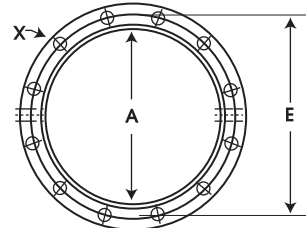

12 Bolts

Intake & Discharge Flanges

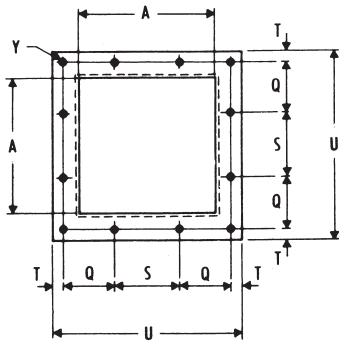

12 Bolts

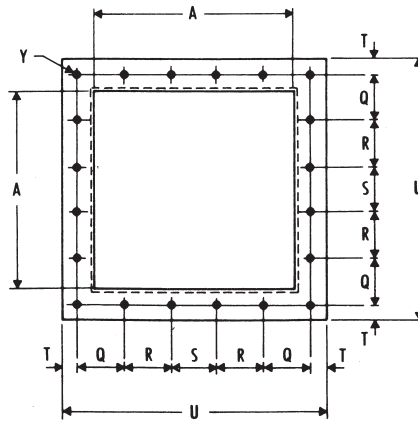

20 Bolts

Screw Size	Flange Bolts		A	E	Q	R	S	T	U
	Tabular X	Discharge Y							
4	6 - 3/8	12 - 1/4	5	7	2 1/4	—	2 1/4	3/8	7 1/2
6	8 - 3/8	12 - 3/8	7	8 7/8	2 13/16	—	3	11/16	10
9	8 - 3/8	12 - 3/8	10	11 7/8	4	—	4	1/2	13
10	8 - 3/8	12 - 3/8	11	13 1/4	4 5/16	—	4 3/8	5/8	14 1/4
12	8 - 1/2	12 - 3/8	13	15	5 1/8	—	5 1/4	7/8	17 1/4
14	8 - 1/2	20 - 3/8	15	17	3 1/2	3 1/2	3 1/2	7/8	19 1/4
16	8 - 5/8	20 - 3/8	17	19 1/2	3 3/4	4	4	7/8	21 1/4
18	10 - 5/8	20 - 1/2	19	22	4 7/16	4 3/8	4 3/8	1 1/8	24 1/4
20	10 - 5/8	20 - 1/2	21	24 3/8	4 7/8	4 3/4	4 3/4	1 1/8	26 1/4
24	12 - 5/8	20 - 1/2	25	28 1/2	5 5/8	5 5/8	5 1/2	1 1/8	30 1/4

Part Name	4	6	9	10	12	14	16	18	20	24
Flange, Trough	6 - 3/8 x 1 1/4	6 - 3/8 x 1 1/4	8 - 3/8 x 1 1/4	8 - 3/8 x 1 1/4	8 - 1/2 x 1 1/2	8 - 1/2 x 1 1/2	8 - 5/8 x 1 3/4	10 - 5/8 x 1 3/4	10 - 5/8 x 1 3/4	12 - 5/8 x 1 3/4
Flange, Tubular Housing	6 - 3/8 x 1 1/4	8 - 3/8 x 1 1/4	8 - 3/8 x 1 1/4	8 - 3/8 x 1 1/4	8 - 1/2 x 1 1/2	8 - 1/2 x 1 1/2	8 - 5/8 x 1 3/4	10 - 5/8 x 1 3/4	10 - 5/8 x 1 3/4	12 - 5/8 x 1 3/4
End, Trough										
Inside	6 - 1/4 x 3/4	7 3/8 x 1	8 - 3/8 x 1 1/4	8 - 3/8 x 1 1/4	8 - 1/2 x 1 1/4	8 - 1/2 x 1 1/4	8 - 5/8 x 1 1/4	10 - 5/8 x 1 1/4	10 - 5/8 x 1 1/2	12 - 5/8 x 1 1/2
Inside Discharge	4 - 3/8 x 1	4 - 3/8 x 1	4 - 3/8 x 1 1/4	6 - 3/8 x 1 1/4	6 - 1/2 x 1 1/4	6 - 1/2 x 1 1/4	6 - 5/8 x 1 1/4	6 - 5/8 x 1 1/2	6 - 5/8 x 1 1/2	6 - 5/8 x 1 1/2
Inside Rectangular	5 1/4 x 3/4	6 - 3/8 x 1	8 - 3/8 x 1 1/4	8 - 3/8 x 1 1/4	10 - 1/2 x 1 1/4	11 - 1/2 x 1 1/4	12 - 5/8 x 1 1/4	12 - 5/8 x 1 1/4	12 - 5/8 x 1 1/2	12 - 5/8 x 1 1/2
Outside Type	6 - 3/8 x 1 1/4	6 - 3/8 x 1 1/4	8 - 3/8 x 1 1/4	8 - 3/8 x 1 1/4	8 - 1/2 x 1 1/2	8 - 1/2 x 1 1/2	8 - 5/8 x 1 3/4	10 - 5/8 x 1 3/4	10 - 5/8 x 1 3/4	12 - 5/8 x 1 3/4
Outside Discharge	4 - 3/8 x 1	2 - 3/8 x 1	4 - 3/8 x 1 1/4	4 - 3/8 x 1 1/4	4 - 1/2 x 1 1/4	4 - 1/2 x 1 1/4	4 - 5/8 x 1 1/2	4 - 5/8 x 1 1/2	4 - 5/8 x 1 1/2	6 - 5/8 x 1 1/2
Ends, Tubular Housing	6 - 3/8 x 1	8 - 3/8 x 1 1/4	8 - 3/8 x 1 1/4	8 - 3/8 x 1 1/4	8 - 1/2 x 1 1/2	8 - 1/2 x 1 1/2	8 - 5/8 x 1 3/4	10 - 5/8 x 1 3/4	10 - 5/8 x 1 3/4	12 - 5/8 x 1 3/4
Hanger, Trough										
Style 60		2 - 1/2 x 2	2 - 1/2 x 2	2 - 1/2 x 2	2 - 1/2 x 2 1/2	2 - 1/2 x 2 1/2	2 - 5/8 x 2 3/4	2 - 5/8 x 2 3/4	2 - 5/8 x 2 3/4	
Style 70		4 - 3/8 x 1	4 - 3/8 x 1 1/4	4 - 3/8 x 1 1/4	4 - 1/2 x 1 1/2	4 - 1/2 x 1 1/2	4 - 1/2 x 1 1/2	4 - 1/2 x 13/4	4 - 5/8 x 2	
Style 216		4 - 3/8 x 1 1/4	4 - 3/8 x 1 1/4	4 - 3/8 x 1 1/4	4 - 1/2 x 1 1/2	4 - 1/2 x 1 1/2	4 - 1/2 x 1 1/2	4 - 5/8 x 13/4	4 - 5/8 x 2	4 - 5/8 x 2 1/2
Style 220	4 - 1/4 x 1	4 - 3/8 x 1	4 - 3/8 x 1	4 - 3/8 x 1	4 - 1/2 x 1 1/4	4 - 1/2 x 1 1/2	4 - 1/2 x 1 1/2	4 - 5/8 x 13/4	4 - 5/8 x 1 3/4	4 - 5/8 x 1 3/4
Style 226	4 - 1/4 x 1	4 - 3/8 x 1 1/4	4 - 3/8 x 1 1/4	4 - 3/8 x 1 1/4	4 - 1/2 x 1 1/2	4 - 1/2 x 1 1/2	4 - 1/2 x 1 1/2	4 - 5/8 x 13/4	4 - 5/8 x 2	4 - 5/8 x 2 1/2
Style 230		4 - 3/8 x 1	4 - 3/8 x 1	4 - 3/8 x 1	4 - 1/2 x 1 1/4	4 - 1/2 x 1 1/2	4 - 1/2 x 1 1/2	4 - 5/8 x 13/4	4 - 5/8 x 1 3/4	4 - 5/8 x 1 3/4
Style 316	4 - 1/4 x 1	4 - 3/8 x 1	4 - 3/8 x 1	4 - 3/8 x 1	4 - 1/2 x 1 1/2	4 - 1/2 x 1 1/4	4 - 1/2 x 1 1/4	4 - 5/8 x 1 1/2	4 - 5/8 x 1 1/2	4 - 5/8 x 1 1/2
Style 326	4 - 1/4 x 1	4 - 3/8 x 1	4 - 3/8 x 1	4 - 3/8 x 1	4 - 1/2 x 1 1/4	4 - 1/2 x 1 1/4	4 - 1/2 x 1 1/4	5 5/8 x 1 1/2	4 - 5/8 x 1 1/2	4 - 5/8 x 1 1/2
Covers, Trough (Std. 10 ft.)	10 - 5/16 x 1	10 - 5/16 x 1	10 - 5/16 x 1	10 - 5/16 x 1	10 - 5/16 x 1	10 - 5/16 x 1	10 - 5/16 x 1	10 - 5/16 x 1	10 - 5/16 x 1	10 - 5/16 x 1
Saddle - Feet										
Flanged Feet										
Saddle (Now Welded)	2 - 3/8 x 1 1/2	2 - 3/8 x 1 1/2	2 - 3/8 x 1 1/2	2 - 3/8 x 1 1/2	2 - 1/2 x 13/4	2 - 1/2 x 13/4	2 - 5/8 x 2	2 - 5/8 x 2	2 - 5/8 x 2	2 - 5/8 x 2
Spouts, Discharge										
Attaching Bolts	8 - 3/8 x 1 1/2	8 - 3/8 x 1 1/2	8 - 3/8 x 1 1/2	8 - 3/8 x 1 1/2	8 - 3/8 x 1 1/2	12 - 3/8 x 1 1/2	12 - 3/8 x 1 1/2	12 - 1/2 x 1 1/2	12 - 1/2 x 1 1/2	12 - 1/2 x 1 1/2
Flange	12 - 3/8 x 1	12 - 3/8 x 1	12 - 3/8 x 1	12 - 3/8 x 1	12 - 3/8 x 1	20 - 3/8 x 1	20 - 3/8 x 1	20 - 1/2 x 1	20 - 1/2 x 1	20 - 1/2 x 1
Flange w/Slide	10 - 3/8 x 1	10 - 3/8 x 1	10 - 3/8 x 1	10 - 3/8 x 1	10 - 3/8 x 1	16 - 3/8 x 1	16 - 3/8 x 1	16 - 1/2 x 1 1/4	16 - 1/2 x 1 1/4	16 - 1/2 x 1 1/4

All bolts hex head cap screws with hex nuts and lock washers.

Bolt Requirements



Part Name	1	1 1/2	2	2 7/16	3	3 7/16
Bearings, End						
Discharge Bronze	3 – 3/8 × 1 1/4	3 – 1/2 × 1 1/2	3 – 5/8 × 1 3/4	3 – 5/8 × 1 3/4	3 – 3/4 × 2	3 – 3/4 × 2 1/4
Discharge Ball	3 – 3/8 × 1 1/4	3 – 1/2 × 1 1/2	3 – 5/8 × 1 1/2	3 – 5/8 × 13/4	3 – 3/4 × 2	3 – 3/4 × 2 1/4
Flanged Bronze	4 – 3/8 × 1 1/4	4 – 1/2 × 1 1/2	4 – 5/8 × 1 3/4	4 – 5/8 × 13/4	4 – 3/4 × 2	4 – 3/4 × 2 1/4
Flanged Ball	4 – 3/8 × 1 1/4	4 – 1/2 × 1 1/2	4 – 5/8 × 1 3/4	4 – 5/8 × 13/4	4 – 3/4 × 2 1/2	4 – 3/4 × 2 3/4
Flanged Roller		4 – 1/2 × 2 1/2	4 – 1/2 × 2 1/2	4 – 5/8 × 3	4 – 3/4 × 3	4 – 3/4 × 3 1/4
Pillow Block Bronze	2 – 3/8 × 1 1/2	2 – 1/2 × 1 3/4	2 – 5/8 × 2	2 – 5/8 × 2 1/4	2 – 3/4 × 2 1/2	2 – 7/8 × 2 3/4
Pillow Block Ball	2 – 3/8 × 1 3/4	2 – 1/2 × 2 1/4	2 – 5/8 × 2 1/2	2 – 5/8 × 2 3/4	2 – 7/8 × 3 1/2	2 – 7/8 × 3 3/4
Pillow Block, Roller		2 – 1/2 × 2 1/4	2 – 5/8 × 2 1/2	2 – 5/8 × 2 3/4	2 – 3/4 × 3	2 – 7/8 × 3 1/2
Bearings, Thrust						
Type "E" Roller		4 – 1/2 × 2 3/4	4 – 1/2 × 2 3/4	4 – 5/8 × 3 1/4	4 – 3/4 × 3 1/2	4 – 3/4 × 3 3/4
Coupling Bolts						
	3/8 × 2 1/16	1/2 × 3	5/8 × 3 5/8	5/8 × 4 3/8	3/4 × 5 – 3" Pipe 3/4 × 5 1/2 – 4" Pipe	7/8 × 5 1/2
Seals, Shafts						
Flanged Gland		4 – 1/2 × 1 1/2	4 – 5/8 × 1 1/2	4 – 5/8 × 1 1/2	4 – 3/4 × 1 3/4	4 – 3/4 × 1 3/4
Plate w/Ball or Bronze		4 – 1/2 × 2	4 – 5/8 × 2 1/4	4 – 5/8 × 2 1/4	4 – 3/4 × 3	4 – 3/4 × 3 1/2
Plate w/Roller		4 – 1/2 × 3	4 1/2 × 3	4 – 5/8 × 3 1/2	4 – 3/4 × 3 1/2	4 – 3/4 × 4
Split Gland		2 – 1/2 × 1 1/2	2 – 1/2 × 1 1/2	2 – 5/8 × 1 3/4	2 – 5/8 × 1 3/4	2 – 3/4 × 2 1/4
Waste Pack, w/Ball or Bronze		4 – 1/2 × 3 1/2	4 – 5/8 × 3 1/2	4 – 5/8 × 4	4 – 3/4 × 4	4 – 3/4 × 5
Waste Pack, w/Roller		4 – 1/2 × 4	4 – 1/2 × 4	4 – 5/8 × 4 1/2	4 – 3/4 × 5	4 – 3/4 × 5 1/2

All other bolts hex head cap screws with hex nuts and lock washers.



Pipe Sizes, Dimensions and Weights

Nominal Pipe Size	Outside Diameter	I.P.S. Schedule			Wall	Inside Diameter	Wt./Ft. (lb)	Nominal Pipe Size	Outside Diameter	I.P.S. Schedule			Wall	Inside Diameter	Wt./Ft. (lb)			
1/8	.405		10S		.049	.307	.1863	3	3.500		5S		.083	3.334	3.029			
		40	40S	Standard	.068	.269	.2447				10S		.120	3.260	4.332			
		80	80S	Extra Heavy	.095	.215	.3145			40	40S	Standard	.216	3.068	7.576			
1/4	.540		10S		.065	.410	.3297			80	80S	Extra Heavy	.300	2.900	10.25			
		40	40S	Standard	.088	.364	.4248			160			.438	2.624	14.32			
		80	80S	Extra Heavy	.119	.302	.5351					XX Heavy	.600	2.300	18.58			
3/8	.675		10S		.065	.545	.4235		3 1/2	4.000		5S		.083	3.834	3.472		
		40	40S	Standard	.091	.493	.5676					10S		.120	3.760	4.973		
		80	80S	Extra Heavy	.126	.423	.7388				40	40S	Standard	.226	3.548	9.109		
1/2	.840		5S		.065	.710	.5383				4	4.500		5S		.083	4.334	3.915
			10S		.083	.674	.6710							10S		.120	4.260	5.613
		40	40S	Standard	.109	.622	.8510						40	40S	Standard	.237	4.026	10.79
		80	80S	Extra Heavy	.147	.546	1.088	80	80S	Extra Heavy			.337	3.826	14.98			
		160			.187	.466	1.304	120					.438	3.624	19.00			
		XX Heavy	.294	.252	1.714	160			.531	3.438			22.51					
3/4	1.050		5S		.065	.920	.6838	5	5.563				5S		.109	5.345	6.349	
			10S		.083	.884	.8572						10S		.134	5.295	7.770	
		40	40S	Standard	.113	.824	1.131			40			40S	Standard	.258	5.047	14.62	
		80	80S	Extra Heavy	.154	.742	1.474			80			80S	Extra Heavy	.375	4.813	20.78	
		160			.218	.614	1.937			120					.500	4.563	27.04	
		XX Heavy	.308	.434	2.441	160							.625	4.313	32.96			
1	1.315		5S		.065	1.185	.8678			6	6.625		5S		.109	6.407	7.585	
			10S		.109	1.097	1.404						10S		.134	6.357	9.289	
		40	40S	Standard	.133	1.049	1.679					40	40S	Standard	.280	6.065	18.97	
		80	80S	Extra Heavy	.179	.957	2.172					80	80S	Extra Heavy	.432	5.761	28.57	
		160			.250	.815	2.844					120			.562	5.491	36.39	
		XX Heavy	.358	.599	3.659	160							.718	5.189	45.30			
1 1/4	1.660		5S		.065	1.530	1.107	8	8.625				5S		.109	8.407	9.914	
			10S		.109	1.442	1.806						10S		.148	8.329	13.40	
		40	40S	Standard	.140	1.380	2.273					20			.250	8.125	22.36	
		80	80S	Extra Heavy	.191	1.278	2.997					30			.277	8.071	24.70	
		160			.250	1.160	3.765					40	40S	Standard	.322	7.981	28.55	
		XX Heavy	.382	.896	5.214	60							.406	7.813	35.64			
1 1/2	1.900		5S		.065	1.770	1.274			8	8.625	80	80S	Extra Heavy	.500	7.625	43.39	
			10S		.109	1.682	2.085					100			.593	7.439	50.87	
		40	40S	Standard	.145	1.610	2.718					120			.718	7.189	60.63	
		80	80S	Extra Heavy	.200	1.500	3.631					140			.812	7.001	67.76	
		160			.281	1.338	4.859							XX Heavy	.875	6.875	72.42	
		XX Heavy	.400	1.100	6.408	160							.906	6.813	74.69			
2	2.375		5S		.065	2.245	1.604	10	10.750				5S		.134	10.482	15.19	
			10S		.109	2.157	2.638						10S		.165	10.420	18.70	
		40	40S	Standard	.154	2.067	3.653					20			.250	10.250	28.04	
		80	80S	Extra Heavy	.218	1.939	5.022					30			.307	10.136	34.24	
		160			.343	1.689	7.444					40	40S	Standard	.365	10.020	40.48	
		XX Heavy	.436	1.503	9.029	60	80S					Extra Heavy	.500	9.750	54.74			
2 1/2	2.875		5S		.083	2.709	2.475			10	10.750	80			.593	9.564	64.33	
			10S		.120	2.635	3.531					100			.718	9.224	76.93	
		40	40S	Standard	.203	2.469	5.793					120			.843	9.064	89.20	
		80	80S	Extra Heavy	.276	2.323	7.661					140			1.000	8.750	104.1	
		160			.375	2.125	10.01					160			1.125	8.500	115.7	
		XX Heavy	.552	1.771	13.69													

NOTE: Weights shown are in pounds per foot, based on the average wall of the pipe. The following formula was used in calculating the weight per foot.

W = 10.68 (D — t)
W = Weight in pounds per foot (to 4 digits)
D = Outside Diameter in inches (to 3 decimal places)
t = Wall thickness in decimals (to 3 decimal places)

All weights are carried to four digits only, the fifth digit being carried forward if five or over, or dropped if under five.

Typical Drive Arrangements



The most common types of drives for Screw Conveyors are illustrated below.

In addition to those shown, other types available are: variable speed drives, hydraulic drives, and take-off drives for connection to other equipment.

For special drive requirements, consult our Engineering Department.

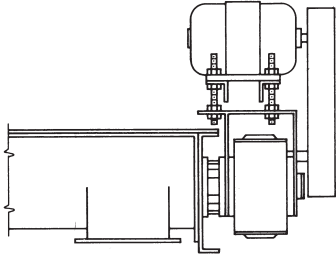
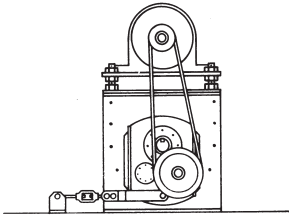
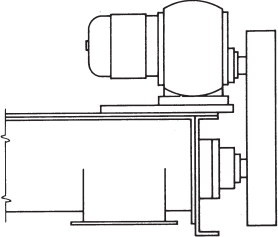
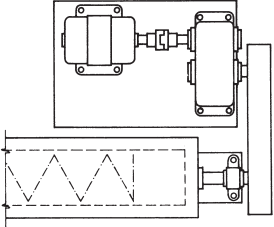
<p>SCREW DRIVER REDUCER</p>	 <p>(Side View)</p>	<p>Reducer mounts on trough end, and is directly connected to the conveyor screw and includes integral thrust bearing, seal gland, and drive shaft. Motor mount may be positioned at top, either side, or below. Separate drive shaft, end bearing, and seal are not required.</p>
<p>SHAFT MOUNTED REDUCER</p>	 <p>(End View)</p>	<p>Reducer mounts on conveyor drive shaft. Motor and "V"-Belt drive may be in any convenient location. The torque arm may be fastened to the floor, or fitted to trough end. Requires extended drive shaft, end bearing, and seal.</p> <p>Note: Requires thrust unit or collars to hold thrust.</p>
<p>GEARMOTOR DRIVE</p>	 <p>(Side View)</p>	<p>Integral motor-reducer with chain drive to conveyor drive shaft. Usually mounted to top of trough by means of an adapter plate.</p>
<p>BASE TYPE REDUCER DRIVE</p>	 <p>(Top View)</p>	<p>Motor direct-coupled to base type reducer, with chain drive to conveyor drive shaft. Usually mounted on floor or platform as close as possible to conveyor.</p>

Helicoid Screw Conveyors

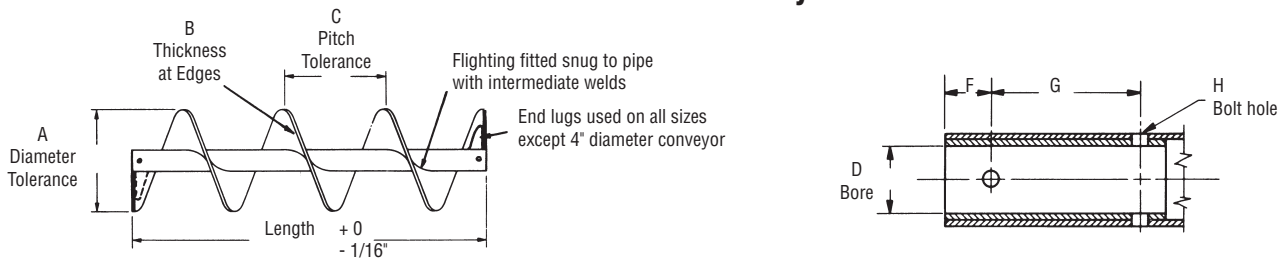

Listed Screw Diameter and Pitch	Coupling Diameter	Size Designation	Pipe Size Schedule 40	Length Feet and Inches	A		B		C		D		F	G	H
					Diameter Tolerance		Thickness		Pitch Tolerance		Bushing Bore Inside Diameter				
					Plus	Minus	Inner Edge	Outer Edge	Plus	Minus	Min.	Max.			
4	1	4H206	1 1/4	9 - 10 1/2	1/16	1/8	3/16	3/32	1/2	1/4	1.005	1.016	1/2	2	13/32
6	1 1/2	6H304	2	9 - 10	1/16	3/16	1/8	1/16	1/2	1/4	1.505	1.516	7/8	3	17/32
6	1 1/2	6H308	2	9 - 10	1/16	3/16	1/4	1/8	3/4	1/4	1.505	1.516	7/8	3	17/32
6	1 1/2	6H312	2	9 - 10	1/16	3/16	3/8	3/16	3/4	1/4	1.505	1.516	7/8	3	17/32
9	1 1/2	9H306	2	9 - 10	1/16	3/16	3/16	3/32	3/4	1/4	1.505	1.516	7/8	3	17/32
9	1 1/2	9H312	2	9 - 10	1/16	3/16	3/8	3/16	3/4	1/4	1.505	1.516	7/8	3	17/32
9	2	9H406	2 1/2	9 - 10	1/16	3/16	3/16	3/32	3/4	1/4	2.005	2.016	7/8	3	21/32
9	2	9H412	2 1/2	9 - 10	1/16	1/4	3/8	3/16	3/4	1/4	2.005	2.016	7/8	3	21/32
9	2	9H414	2 1/2	9 - 10	1/16	1/4	7/16	7/32	3/4	1/4	2.005	2.016	7/8	3	21/32
10	1 1/2	10H306	2	9 - 10	1/16	3/16	3/16	3/32	3/4	1/4	1.505	1.516	7/8	3	17/32
10	2	10H412	2 1/2	9 - 10	1/16	1/4	3/8	3/16	3/4	1/4	2.005	2.016	7/8	3	21/32
12	2	12H408	2 1/2	11 - 10	1/8	5/16	1/4	1/8	1	1/4	2.005	2.016	7/8	3	21/32
12	2	12H412	2 1/2	11 - 10	1/8	5/16	3/8	3/16	1	1/4	2.005	2.016	7/8	3	21/32
12	2 7/16	12H508	3	11 - 9	1/8	5/16	1/4	1/8	1	1/4	2.443	2.458	15/16	3	21/32
12	2 7/16	12H512	3	11 - 9	1/8	5/16	3/8	3/16	1	1/4	2.443	2.458	15/16	3	21/32
12	3	12H614	3 1/2	11 - 9	1/8	3/8	7/16	7/32	1	1/4	3.005	3.025	1	3	25/32
14	2 7/16	14H508	3	11 - 9	1/8	5/16	1/4	1/8	1	1/4	2.443	2.458	15/16	3	21/32
14	3	14H614	3 1/2	11 - 9	1/8	3/8	7/16	7/32	1	1/4	3.005	3.025	1	3	25/32
16	3	16H610	3 1/2	11 - 9	1/8	3/8	5/16	5/32	1 1/2	1/4	3.005	3.025	1	3	25/32
16	3	16H614	4	11 - 9	1/8	3/8	7/16	7/32	1 1/2	1/4	3.005	3.025	1	3	25/32

NOTE: All dimensions in inches.

Cut Flight / Cut & Folded Flight Conveyors

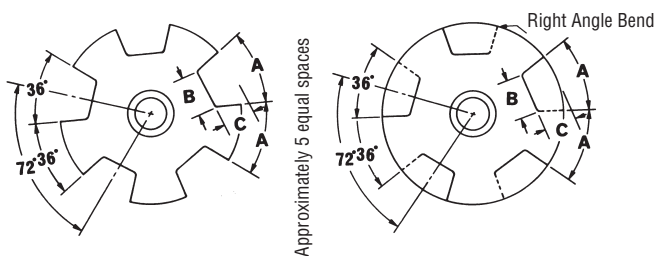

Screw Diameter	A	B	C
4	1 3/8	1	5/8
6	2	1 1/2	7/8
9	3	2 1/8	1 1/2
10	3 3/8	2 1/4	1 3/4
12	4	2 3/4	2
14	4 5/8	3 1/8	2 1/2
16	5 1/4	3 1/2	3
18	6	3 7/8	3 3/8
20	6 5/8	4 1/4	3 7/8
24	7 7/8	4 7/8	4 7/8

Depth of cut "C" is one half the flight width for normal maximum pipe size. Lengths "A" and "B" are calculated from the developed O.D. for standard pitch.

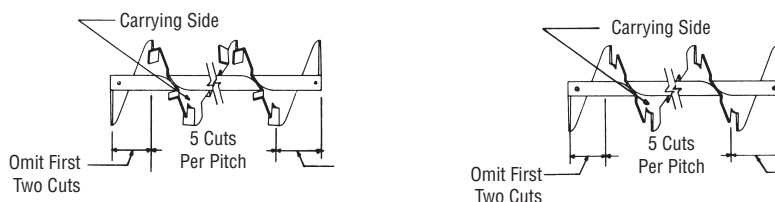

Sectional Screw Conveyors

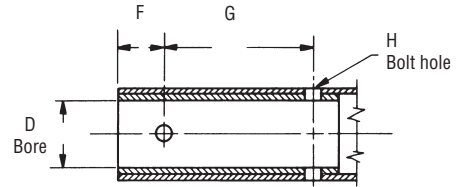
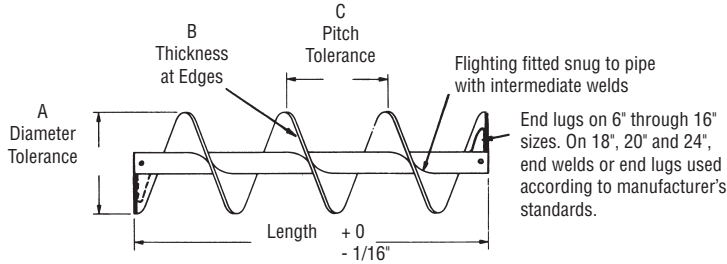

Listed Screw Diameter and Pitch	Coupling Diameter	Size Designation	Pipe Size Schedule 40	Length Feet and Inches	A		B	C		D		F	G	H
					Diameter Tolerance			Pitch Tolerance	Bushing Bore Inside Diameter					
					Plus	Minus	Plus		Minus	Min.	Max.	Spacing 1st Bolt Hole	Centers 2nd Bolt Hole	Nominal Bolt Hole Size
6	1 1/2	6S312	2	9 – 10	1/16	3/16	3/16	3/8	1/4	1.505	1.516	7/8	3	17/32
9	1 1/2	9S312	2	9 – 10	1/16	3/16	3/16	1/2	1/4	1.505	1.516	7/8	3	17/32
	2	9S412	2 1/2	9 – 10	1/16	3/16	3/16	1/2	1/4	2.005	2.016	7/8	3	21/32
9	2	9S416	2 1/2	9 – 10	1/16	1/4	1/4	1/2	1/4	2.005	2.016	7/8	3	21/32
	2	10S412	2 1/2	9 – 10	1/16	3/16	3/16	1/2	1/4	2.005	2.016	7/8	3	21/32
12	2	12S412	2 1/2	11 – 10	1/8	5/16	3/16	3/4	1/4	2.005	2.016	7/8	3	21/32
	2 7/16	12S512	3	11 – 9	1/8	5/16	3/16	3/4	1/4	2.443	2.458	15/16	3	21/32
	2 7/16	12S516	3	11 – 9	1/8	5/16	1/4	3/4	1/4	2.443	2.458	15/16	3	21/32
	3	12S616	3 1/2	11 – 9	1/8	5/16	1/4	3/4	1/4	3.005	3.025	1	3	25/32
	3	12S624	3 1/2	11 – 9	1/8	3/8	3/8	3/4	1/4	3.005	3.025	1	3	25/32
14	2 7/16	14S512	3	11 – 9	1/8	5/16	3/16	3/4	1/4	2.443	2.458	15/16	3	21/32
	3	14S616	3 1/2	11 – 9	1/8	5/16	1/4	3/4	1/4	3.005	3.025	1	3	25/32
	3	14S624	3 1/2	11 – 9	1/8	3/8	3/8	3/4	1/4	3.005	3.025	1	3	25/32
16	3	16S612	3 1/2	11 – 9	1/8	3/8	3/16	3/4	1/4	3.005	3.025	1	3	25/32
	3	16S616	3 1/2	11 – 9	1/8	3/8	1/4	3/4	1/4	3.005	3.025	1	3	25/32
	3	16S624	3 1/2	11 – 9	1/8	3/8	3/8	3/4	1/4	3.005	3.025	1	3	25/32
	3	16S632	3 1/2	11 – 9	1/8	1/2	1/2	3/4	1/4	3.005	3.025	1	3	25/32
18	3	18S612	3 1/2	11 – 9	3/16	3/8	3/16	3/4	1/2	3.005	3.025	1	3	25/32
	3	18S616	3 1/2	11 – 9	3/16	3/8	1/4	3/4	1/2	3.005	3.025	1	3	25/32
	3	18S624	3 1/2	11 – 9	3/16	3/8	3/8	3/4	1/2	3.005	3.025	1	3	25/32
	3	18S632	3 1/2	11 – 9	3/16	1/2	1/2	3/4	1/2	3.005	3.025	1	3	25/32
20	3	20S612	3 1/2	11 – 9	3/16	3/8	3/16	7/8	1/2	3.005	3.025	1	3	25/32
	3	20S616	3 1/2	11 – 9	3/16	3/8	1/4	7/8	1/2	3.005	3.025	1	3	25/32
	3	20S624	3 1/2	11 – 9	3/16	3/8	3/8	7/8	1/2	3.005	3.025	1	3	25/32
24	3 7/16	24S712	4	11 – 8	3/16	3/8	3/16	7/8	1/2	3.443	3.467	1 1/2	4	29/32
	3 7/16	24S716	4	11 – 8	3/16	3/8	1/4	7/8	1/2	3.443	3.467	1 1/2	4	29/32
	3 7/16	24S724	4	11 – 8	3/16	3/8	3/8	7/8	1/2	3.443	3.467	1 1/2	4	29/32
	3 7/16	24S732	4	11 – 8	3/16	1/2	1/2	7/8	1/2	3.443	3.467	1 1/2	4	29/32

NOTE: All dimensions in inches.

COMPONENTS	PAGE
COMPONENT SELECTION	H-50
TROUGH	H-52
DISCHARGES AND GATES	H-56
TROUGH ENDS	H-62
SADDLES AND FEET/TROUGH END FLANGES	H-69
END BEARINGS	H-70
THRUST BEARINGS	H-72
SEALS	H-74
CONVEYOR SCREWS.....	H-77
COUPLING BOLTS, INTERNAL COLLARS AND LUGS	H-85
SHAFTS	H-86
HANGERS	H-91
HANGER BEARINGS	H-99
COVERS	H-101
COVER ACCESSORIES.....	H-104
CONVEYOR SHROUDS	H-106

Required Information

- Screw diameter
- Shaft diameter
- Material component group
- Unusual material characteristics

Conveyor Screws

Standard length conveyor screws should be used whenever possible to reduce the number of hanger bearings required.

The recommended screws listed in the Component Series Table are standard helicoid and sectional screw conveyors. The use of helicoid or sectional conveyors is largely a matter of individual preference.

Right hand screw conveyors pull material toward the end which is being rotated in a clockwise direction. If the rotation is reversed (counterclockwise), the material is pushed away from that end.

In left hand screw conveyors, the material flow is opposite to that of right hand screws, the direction of rotation being unchanged.

To determine hand of screw see pages H-37 and H-38.

The material is carried on one face of the conveyor flighting in conveyors which are required to transport material in one direction, therefore, conveyor end lugs are located on the opposite face to facilitate unimpeded flow of the material. Conveyor sections must be installed in such a manner that all end lugs are toward the inlet end of the conveyor. Conveyor sections must not be turned end for end without reversing the direction of rotation, or conversely, the direction of rotation must not be reversed without turning the conveyor sections end for end.

Requirements for reversible conveyor screws intended for material transport in either direction should be referred to our Engineering Department.

Flighting should be omitted from the conveyor pipe over the last discharge opening to ensure complete discharge of material without carryover.

Continuity of material flow at hanger points is accomplished by opposing adjacent flight ends approximately 180°. (As close to 180° as the predrilled holes will allow.)

Conveyor Trough and Tubular Housing

Standard trough and housing sections are available in five, six, ten, and 12 foot lengths. Standard five and six foot lengths should be used when connecting flanges coincide with discharge openings or hanger bearings.

Shafts

The primary consideration in determining the type and size of coupling and drive shafts is whether the shafts selected are adequate to transmit the horsepower required, including any overload. Normally, cold-rolled shafts are adequate. However, high-tensile shafts may be required due to torque limitations. Also, stainless steel shafts may be necessary when corrosive or contaminable materials are to be handled. Conveyors equipped with non-lubricated hard iron hanger bearings require hardened coupling shafts. Specific shaft size determination is covered in the Torsional Rating Section, page H-26.

Shaft Seals

Several conveyor end seal types are available to prevent contamination of the conveyed material or to prevent the escape of material from the system.

Bearings

Hanger Bearing. The purpose of hanger bearings is to provide intermediate support when multiple screw sections are used. Hanger bearings are designed primarily for radial loads. Therefore, adequate clearance should be allowed between the bearings and the conveyor pipe ends to prevent damage by the thrust load which is transmitted through the conveyor pipe.

The hanger bearing recommendations listed in the Material Characteristic Tables are generally adequate for the material to be handled. Often, however, unusual characteristics of the material or the conditions under which the conveyor must operate make it desirable to use special bearing materials. Regarding the use of special bearing materials, consult our Engineering Department.

End Bearings. Several end bearing types are available, and their selection depends on two basic factors: Radial load and thrust load. The relative values of these loads determines end bearing types.

Radial load is negligible at the conveyor tail shaft. However, drive ends (unless integrated with the conveyor end plate) are subject to radial loading due to overhung drive loads, such as chain sprockets or shaft-mounted speed reducers. Screw Conveyor Drive Reducers at the drive end will adequately carry both thrust and radial loads.

Discharge Spouts and Gates

Standard discharge spouts and gates are available for either conveyor trough or tubular housing in several designs, operated either manually or by remote controls.

In installations where it is possible to overfill the device to which material is being transported, an additional overflow discharge opening or overflow relief device should be provided. Consult our Engineering Department for suggested electrical interlock and safety devices to prevent overflow or damage to equipment.

It is sometimes found that the material characteristics are such that standard component specifications are inadequate. Should unusual material characteristics or severe conditions exist, our Engineering Department should be consulted.

Conveyor Ends

A complete line of conveyor ends are available as standard for either conveyor trough or tubular housing with a choice of many bearing types and combinations.

Special Applications

More common of the unusual material characteristics which require other than the recommended components are:

Corrosive Materials. Components may be fabricated from alloys not affected by the material or may be coated with a protective substance.

Contaminable Materials. Require the use of oil impregnated, sealed, or dry type hanger bearings. End shafts should be sealed to prevent entrance of contaminants from the outside. Due to the necessity for frequent cleaning conveyor components should be designed for convenient disassembly.

Abrasive Materials. These materials may be handled in conveyors, troughs, or housings constructed of abrasion resistant alloys with hard surfaced screws. Lining of all exposed surfaces with rubber or special resins also materially reduces abrasive damage.

Interlocking or Matting Materials. Conveying with standard components is sometimes possible by the use of special feeding devices at the conveyor inlet.

Hygroscopic Materials. Frequently these materials may be handled successfully in a conveyor which is substantially sealed from the exterior atmosphere. In extreme cases it is necessary to provide jacketed trough or housing with an appropriate circulating medium to maintain the material at an elevated temperature. Purging of the conveyor with a suitable dry gas is also used in some installations.

Viscous or Sticky Materials. Ribbon flight conveyor screws are most frequently used for conveying these materials although standard components may be specially coated to improve the flow of material.

Harmful Vapors or Dusts. These materials may be safely handled in dust sealed trough, plain tubular housing, or gasketed flanged tubular housing with particular attention to shaft sealing. Trough or housing exhaust systems have also been successfully used in some installations.

Blending in Transit. Ribbon, cut flight, paddle, or a combination of these screw types may be designed to produce the desired degree of blending, aeration or mixing.

Explosive Dusts. The danger of this condition may be minimized in most installations by the use of components which are fabricated from non-ferrous materials and proper conveyor sealing techniques observed. Exhaust systems are also advisable for the removal of explosive dusts.

Materials Subject to Packing. This condition requires the use of aerating devices at the conveyor inlet when materials are pulverulent and a special feeder device when material particles are large or fibrous.

Materials which are Fluid when Aerated. This condition may be used to advantage in some installations by declining the conveyor system toward the discharge end.

Degradable Materials. Some particles that are easily broken or distorted may usually be handled in screw conveyors by reducing the speed and selecting a larger conveyor size sufficient to deliver the required volume of material.

Elevated Temperature. Components should be fabricated from high temperature alloys. Should the process be such that cooling of the material in the conveyor is permissible, jacketed trough or housing may be used at the inlet end to cool the material and standard components used after the point where material temperature has been reduced to a safe degree.

Conveyor Trough

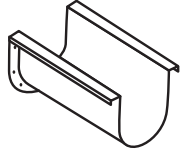
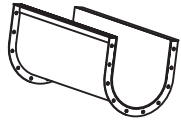
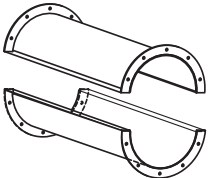
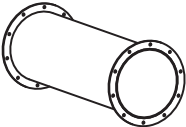
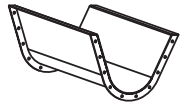
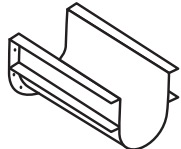
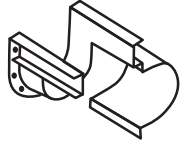
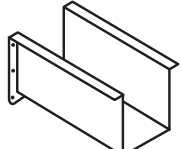
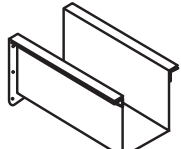
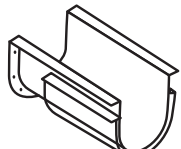
<p>FORMED FLANGE U-TROUGH</p>		<p>Commonly used economical trough. One piece construction. Standard lengths in stock</p>
<p>ANGLE FLANGE U-TROUGH</p>		<p>Rigid construction. Standard lengths in stock.</p>
<p>FORMED FLANGE TUBULAR U-TROUGH</p>		<p>Loadable to full cross section for feeder applications. Minimizes fall back in inclined applications. Easily taken apart for maintenance. Can be gasketed for dust tight enclosure. Hanger pockets required for use with standard hangers.</p>
<p>SOLID TUBULAR TROUGH</p>		<p>One piece construction for totally enclosed or inclined applications. Hanger pockets required for use with standard hangers.</p>
<p>FLARED TROUGH</p>		<p>Used where materials tend to bridge or when flared inlets are needed.</p>
<p>CHANNEL TROUGH</p>		<p>Adds structural support for longer than standard spans.</p>
<p>DROP BOTTOM TROUGH</p>		<p>Used when complete material clean-out is critical. Can be furnished with hinges either side and bolts or clamps opposite side.</p>
<p>FORMED FLANGE RECTANGULAR TROUGH</p>		<p>Material being conveyed forms its own trough thereby reducing trough wear. One piece construction.</p>
<p>ANGLE FLANGE RECTANGULAR TROUGH</p>		<p>The same as formed flange rectangular except top flanges are made from structural angle.</p>
<p>JACKETED TROUGH</p>		<p>Jacket allows heating or cooling of material being conveyed.</p>

Standard conveyor troughs have a U-shaped steel body with angle iron top flanges or formed top flanges and jig drilled end flanges.

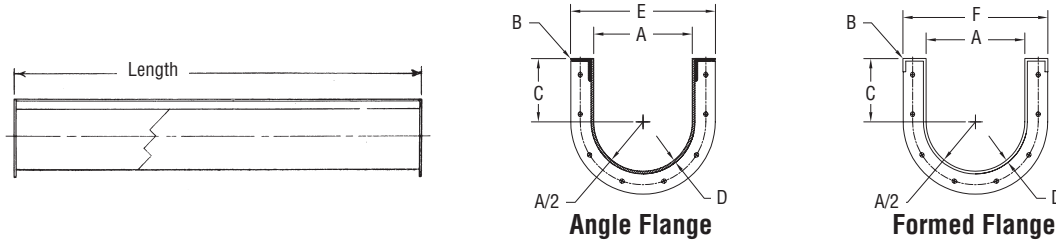

Conveyor Diameter	D Trough Thickness	Angle Flanged Trough				Formed Flanged Trough ▲				A	B	C	E	F		
		Part Number	Weight				Part Number	Weight								
			10' Length	5' Length	12' Length	6' Length		10' Length	5' Length						12' Length	6' Length
4	□ 16 GA.	4CTA16	53	29	—	—	4CTF16	41	23	—	—	5	1 1/4	3 5/8	7 3/4	
	14	4CTA14	60	33	—	—	4CTF14	50	28	—	—				7 13/16	
	12	4CTA12	78	42	—	—	4CTF12	70	38	—	—				7 15/16	
6	□ 16 GA.	6CTA16	67	44	—	—	6CTF16	55	32	—	—	7	1 1/4	4 1/2	9 3/4	
	14	6CTA14	78	49	—	—	6CTF14	67	38	—	—				9 13/16	
	12	6CTA12	101	60	—	—	6CTF12	91	50	—	—				9 15/16	
	10	6CTA10	123	73	—	—	6CTF10	117	64	—	—				10 1/16	
	3/16	6CTA7	164	86	—	—	6CTF7	150	79	—	—				9 7/8	
9	16 GA.	9CTA16	113	66	—	—	9CTF16	83	51	—	—	10	1 1/2	6 1/8	13 1/4	
	□ 14	9CTA14	127	73	—	—	9CTF14	99	59	—	—				13 5/16	
	12	9CTA12	156	87	—	—	9CTF12	132	75	—	—				13 7/16	
	10	9CTA10	176	102	—	—	9CTF10	164	91	—	—				13 9/16	
	3/16	9CTA7	230	124	—	—	9CTF7	214	116	—	—				13 3/8	
1/4	9CTA3	286	152	—	—	9CTF3	276	147	—	—	13 1/2					
10	16 GA.	10CTA16	118	69	—	—	10CTF16	88	54	—	—	11	1 1/2	6 3/8	14 1/4	
	□ 14	10CTA14	133	76	—	—	10CTF14	105	62	—	—				14 5/16	
	12	10CTA12	164	92	—	—	10CTF12	140	80	—	—				14 7/16	
	10	10CTA10	178	102	—	—	10CTF10	167	91	—	—				14 9/16	
	3/16	10CTA7	233	131	—	—	10CTF7	217	123	—	—				14 3/8	
	1/4	10CTA3	306	163	—	—	10CTF3	296	158	—	—				14 1/2	
12	□ 12 GA.	12CTA12	197	113	236	135	12CTF12	164	95	197	114	13	2	7 3/4	17 7/16	
	10	12CTA10	234	133	281	160	12CTF10	187	117	224	140				17 9/16	
	3/16	12CTA7	294	164	353	197	12CTF7	272	150	326	180				17 3/8	
	1/4	12CTA3	372	203	446	244	12CTF3	357	194	428	233				17 1/2	
14	□ 12 GA.	14CTA12	214	121	257	145	14CTF12	183	102	219	122	15	2	9 1/4	19 7/16	
	10	14CTA10	258	143	309	172	14CTF10	207	127	248	152				19 9/16	
	3/16	14CTA7	328	180	394	216	14CTF7	304	168	365	202				19 3/8	
	1/4	14CTA3	418	224	501	269	14CTF3	403	215	483	258				19 1/2	
16	□ 12 GA.	16CTA12	238	133	285	160	16CTF12	206	107	247	128	17	2	10 5/8	21 7/16	
	10	16CTA10	288	159	345	191	16CTF10	234	144	281	173				21 9/16	
	3/16	16CTA7	368	200	442	240	16CTF7	345	188	414	226				21 3/8	
	1/4	16CTA3	471	243	565	291	16CTF3	455	228	546	273				21 1/2	
18	□ 12 GA.	18CTA12	252	159	302	191	18CTF12	240	133	288	160	19	2 1/2	12 1/8	24 7/16	
	10	18CTA10	353	170	423	204	18CTF10	269	165	323	198				24 9/16	
	3/16	18CTA7	444	243	533	291	18CTF7	394	217	473	260				24 3/8	
	1/4	18CTA3	559	298	671	358	18CTF3	520	275	624	330				24 1/2	
20	□ 10 GA.	20CTA10	383	228	460	274	20CTF10	296	190	355	228	21	2 1/2	13 1/2	26 9/16	
	3/16	20CTA7	484	271	581	325	20CTF7	434	247	521	296				26 3/8	
	1/4	20CTA3	612	334	734	401	20CTF3	573	315	687	378				26 1/2	
24	□ 10 GA.	24CTA10	443	255	531	306	24CTF10	384	227	461	272	25	2 1/2	16 1/2	30 9/16	
	3/16	24CTA7	563	319	676	383	24CTF7	514	293	617	352				30 3/8	
	1/4	24CTA3	717	363	860	435	24CTF3	678	339	813	406				30 1/2	

□ Standard Gauge Bolt Patterns on page H-41

▲ Double formed flange standard on all sizes through 10 ga.

All troughs available in other materials such as stainless, aluminum, abrasion resistant, etc.

Tubular Housing



Tubular conveyor housings are inherently dust and weather-tight, and may be loaded to a full cross section. Conveyors with tubular housings are rigid and are highly suitable for conveying material on an incline. Three types shown are available.

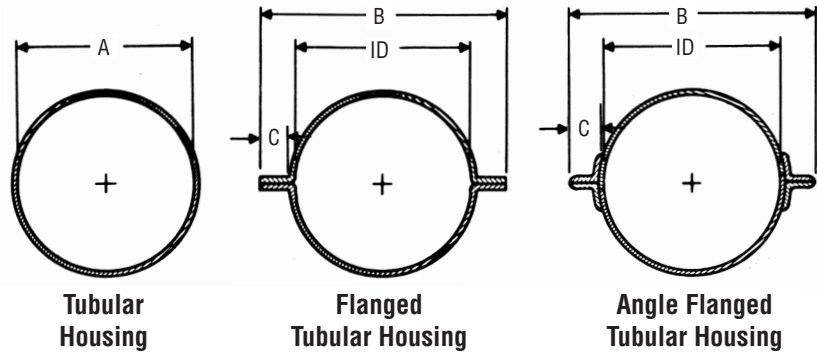

Conveyor Diameter	Trough Thickness	Tubular Housing				Formed Flanged		Angle Flanged		A	B	C
		Part Number	Weight		Part Number	Weight	Part Number	Weight				
			10' Length	5' Length					10' Length			
4	□ 16 GA.	4CHT16			4CHT16-F	43	4CHT16-A	81	5	7 1/8	1	
	14	4CHT14	60	31	4CHT14-F	53	4CHT14-A	89				
	12	4CHT12			4CHT12-F	74	4CHT12-A	106				
6	□ 16 GA.	6CHT16	50	27	6CHT16-F	60	6CHT16-A	110	7	9 5/8	1 1/4	
	14	6CHT14	62	33	6CHT14-F	75	6CHT14-A	122				
	12	6CHT12	85	44	6CHT12-F	103	6CHT12-A	145				
	10	6CHT10	109	56	6CHT10-F	133	6CHT10-A	187				
	3/16	6CHT7	145	74	6CHT7-F	168	6CHT7-A	205				
9	16 GA.	9CHT16	72	39	9CHT16-F	84	9CHT16-A	131	10	12 5/8	1 1/4	
	□ 14	9CHT14	89	47	9CHT14-F	104	9CHT14-A	148				
	12	9CHT12	122	64	9CHT12-F	143	9CHT12-A	181				
	10	9CHT10	155	80	9CHT10-F	182	9CHT10-A	214				
	3/16	9CHT7	208	107	9CHT7-F	245	9CHT7-A	267				
	1/4	9CHT3	275	140	9CHT3-F	324	9CHT3-A	334				
10	16 GA.	10CHT16	79	42	10CHT16-F	91	10CHT16-A	138	11	13 5/8	1 1/4	
	□ 14	10CHT14	97	52	10CHT14-F	112	10CHT14-A	156				
	12	10CHT12	133	70	10CHT12-F	154	10CHT12-A	192				
	10	10CHT10	169	88	10CHT10-F	196	10CHT10-A	228				
	3/16	10CHT7	227	117	10CHT7-F	264	10CHT7-A	286				
	1/4	10CHT3	301	154	10CHT3-F	350	10CHT3-A	360				
12	□ 12 GA.	12CHT12	163	88	12CHT12-F	193	12CHT12-A	235	13	16 1/4	1 1/2	
	10	12CHT10	208	111	12CHT10-F	247	12CHT10-A	280				
	3/16	12CHT7	275	144	12CHT7-F	328	12CHT7-A	347				
	1/4	12CHT3	362	188	12CHT3-F	432	12CHT3-A	434				
14	□ 12 GA.	14CHT12	187	101	14CHT12-F	217	14CHT12-A	259	15	18 1/4	1 1/2	
	10	14CHT10	236	126	14CHT10-F	275	14CHT10-A	308				
	3/16	14CHT7	316	166	14CHT7-F	369	14CHT7-A	388				
	1/4	14CHT3	416	216	14CHT3-F	486	14CHT3-A	488				
16	□ 12 GA.	16CHT12	212	114	16CHT12-F	242	16CHT12-A	310	17	21 1/4	2	
	10	16CHT10	268	142	16CHT10-F	307	16CHT10-A	366				
	3/16	16CHT7	358	187	16CHT7-F	411	16CHT7-A	456				
	1/4	16CHT3	472	244	16CHT3-F	542	16CHT3-A	570				
18	□ 12 GA.	18CHT12	242	133	18CHT12-F	280	18CHT12-A	340	19	23 1/4	2	
	10	18CHT10	304	164	18CHT10-F	352	18CHT10-A	402				
	3/16	18CHT7	405	214	18CHT7-F	471	18CHT7-A	503				
	1/4	18CHT3	533	278	18CHT3-F	621	18CHT3-A	631				
20	□ 10 GA.	20CHT10	335	188	20CHT10-F	381	20CHT10-A	433	21	25 5/16	2	
	3/16	20CHT7	446	237	20CHT7-F	510	20CHT7-A	544				
	1/4	20CHT3	586	307	20CHT3-F	671	20CHT3-A	684				
24	□ 10 GA.	24CHT10	399	215	24CHT10-F	445	24CHT10-A	497	25	29 5/16	2	
	3/16	24CHT7	531	281	24CHT7-F	594	24CHT7-A	629				
	1/4	24CHT3	699	365	24CHT3-F	784	24CHT3-A	797				

□ Standard Gauge Bolt Patterns on page H-42

Flared troughs are used primarily to convey materials which are not free-flowing or which have a tendency to stick to the trough.

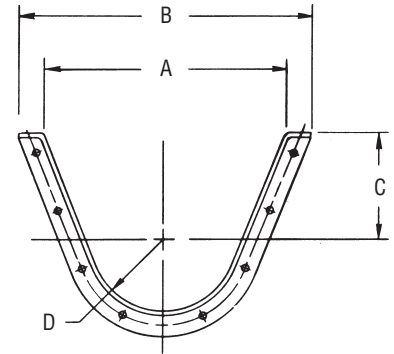
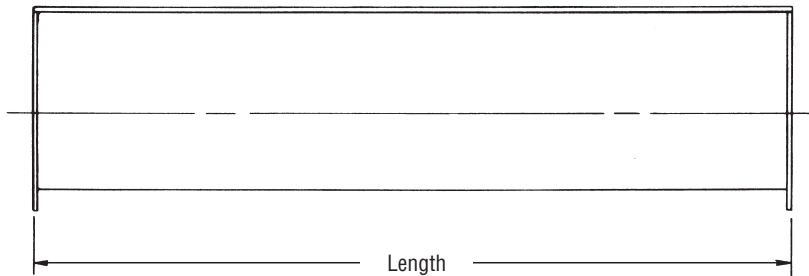

Conveyor Diameter	Trough Thickness	Part Number	Weight Per Foot	A	B	C	D	Standard Length Foot
6	□ 14 GA.	6FCT14	9	14	16 5/8	7	3 1/2	10
	12	6FCT12	12		16 3/4			
9	□ 14 GA.	9FCT14	13	18	21 3/16	9	5	10
	12	9FCT12	14		21 1/4			
	10	9FCT10	19		21 1/4			
	3/16	9FCT7	22		21 3/8			
	1/4	9FCT3	25		21 1/2			
12	□ 12 GA.	12FCT12	20	22	26 1/4	10	6 1/2	12
	10	12FCT10	24		26 1/4			
	3/16	12FCT7	32		26 3/8			
	1/4	12FCT3	43		26 1/2			
14	□ 12 GA.	14FCT12	23	24	28 1/4	11	7 1/2	12
	10	14FCT10	27		28 1/4			
	3/16	14FCT7	37		28 3/8			
	1/4	14FCT3	49		28 1/2			
16	□ 12 GA.	16FCT12	25	28	32 1/4	11 1/2	8 1/2	12
	10	16FCT10	31		32 1/4			
	3/16	16FCT7	39		32 3/8			
	1/4	16FCT3	52		32 1/2			
18	□ 12 GA.	18FCT12	27	31	36 1/4	12 1/8	9 1/2	12
	10	18FCT10	35		36 1/4			
	3/16	18FCT7	45		36 3/8			
	1/4	18FCT3	56		36 1/2			
20	□ 10 GA.	20FCT10	36	34	39 1/4	13 1/2	10 1/2	12
	3/16	20FCT7	48		39 3/8			
	1/4	20FCT3	60		39 1/2			
24	□ 10 GA.	24FCT10	41	40	45 1/4	16 1/2	12 1/2	12
	3/16	24FCT7	54		45 3/8			
	1/4	24FCT3	69		45 1/2			

□ Standard Gauge Bolt Patterns on page H-41

Discharges and Gates



Discharge Spout Index

14

TSD

12

Conveyor
Diameter



TSD - Plain, Fixed Spout
TSDS - Plain Fixed Spout W/Slide
TSDF - Flush End Spout
RPF - Rack & Pinion/Flat Side

Types

RPF - Rack & Pinion/Flat Slide Dust Tight
RPC - Rack & Pinion/Curved Slide
RPCD - Rack & Pinion/Curved Slide Dust Tight

Spout Thickness

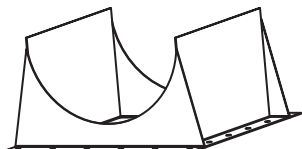
16 - 16 Gauge
14 - 14 Gauge
12 - 12 Gauge
10 - 10 Gauge
7 - 3/16

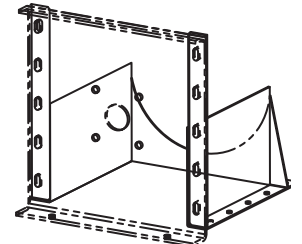
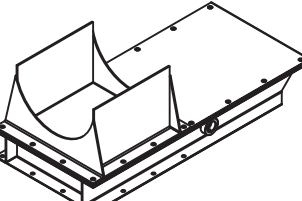
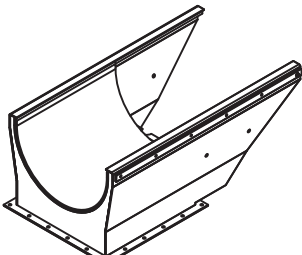
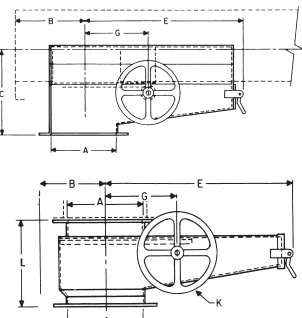
<p>STANDARD DISCHARGE SPOUT</p>		<p>Most commonly used. Flanged hole drilling is per CEMA Standards. Select spout thickness according to trough thickness.</p>
<p>STANDARD DISCHARGE</p>		<p>Standard spout shown above with the addition of the slide and side guides. Select spout thickness according to trough thickness.</p>
<p>FLUSH END DISCHARGE SPOUT</p>		<p>Reduces distance from centerline of discharge to end of the conveyor which eliminates ledge at end of trough and product build-up. Special flush-end trough ends required when this style of discharge is used.</p>
<p>FLAT SLIDE GATE</p>		<p>Rack & pinion type available with hand wheel, rope wheel, pocket wheel and chain. Discharge spout is included when fitted. Flat slide (less rack & pinion) can be furnished with pneumatic, hydraulic, or electric actuators. (Not dust-tight).</p>
<p>CURVED SLIDE GATE</p>		<p>Contoured shape of slide eliminates pocket found in flat slide type. Rack & pinion type available with handwheel, or rope wheel, or pocket wheel with chain. Curved slide (less rack & pinion) can be furnished with pneumatic, hydraulic, or electric actuators. (Standard curved slide gate is not dust-tight.) All curved slide gates should be <u>installed at factory</u>.</p>
<p>DUST TIGHT RACK AND PINION FLAT SLIDE</p>		<p>Dust tight rack and pinions are totally enclosed and can be furnished with either flat or curved slide. Handwheel is normally furnished but is also available with chain or rope wheel.</p>

Plain Opening

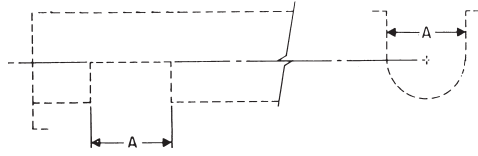

Plain spout openings are cut in the trough permitting free material discharge.

Fixed Spout with Slide Gate

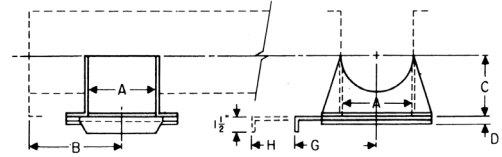

Fixed spouts with slide gates are used where distribution of material is to be controlled. Bolted flange permits slide to be operated from any side

Fixed Spout

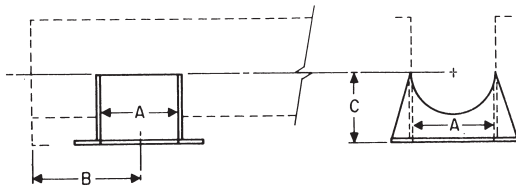

Fixed spouts are fabricated in proportion to size and thickness of trough. Can be furnished loose or welded to trough.

Flush End Spout

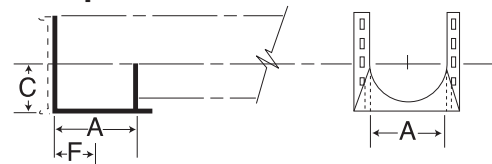

Flush end discharge spouts are designed for use at the final discharge point. The end of the spout is comprised of a housing end with bottom flange drilled with standard discharge flange bolt pattern. Because it is located at the extreme end of the conveyor, there is no carryover of material past the final discharge point. The flush end arrangement eliminates the unnecessary extension of trough and interior components beyond the actual discharge point.

Screw Diameter	A	B	C	D	G	H	F
4	5	4 1/2	3 3/4	5/16	5 5/8	11	2 1/2
6	7	6	5	5/16	6 5/8	14	3 1/2
9	10	8	7 1/8	5/16	8	19	5
10	11	9	7 7/8	5/16	8 3/8	20	5 1/2
12	13	10 1/2	8 7/8	5/16	10 1/8	24	6 1/2
14	15	11 1/2	10 1/8	5/16	11 1/4	27	7 1/2
16	17	13 1/2	11 1/8	5/16	12 3/8	30	8 1/2
18	19	14 1/2	12 3/8	5/16	13 3/8	33	9 1/2
20	21	15 1/2	13 3/8	3/8	14 3/8	36	10 1/2
24	25	17 1/2	15 3/8	3/8	16 3/8	42	12 1/2

Screw Diameter	Trough Thickness Gauge	Spout and Gate Thickness Gauge	Part Number			Weight		
			Fixed Spout		Flush End Spout	Fixed Spout		Flush End Spout
			Plain	With Slide		Plain	Slide	
4	16 - 14	□ 14	4TSD14	4TSDS14	4TSDF14	2	6	1.5
	12	12	4TSD12	4TSDS12	4TSDF12	3	7	2.25
6	14 - 12	□ 14	6TSD14	6TSDS14	6TSDF14	4	11	3.0
	3/16	12	6TSD12	6TSDS12	6TSDF12	6	13	4.50
9	16 - 14 - 12 - 10	□ 14	9TSD14	9TSDS14	9TSDF14	8	18	6.0
	3/16 - 1/4	10	9TSD10	9TSDS10	9TSDF10	13	22	9.75
10	14 - 12 - 10	□ 14	10TSD14	10TSDS14	10TSDF14	10	21	7.5
	3/16 - 1/4	10	10TSD10	10TSDS10	10TSDF10	16	27	12.0
12	12 - 10	□ 12	12TSD12	12TSDS12	12TSDF12	17	36	12.75
	3/16 - 1/4	3/16	12TSD7	12TSDS7	12TSDF7	29	48	21.75
14	12 - 10	□ 12	14TSD12	14TSDS12	14TSDF12	22	46	16.50
	3/16 - 1/4	3/16	14TSD7	14TSDS7	14TSDF7	38	62	28.50
16	12 - 10	□ 12	16TSD12	16TSDS12	16TSDF12	21	49	15.75
	3/16 - 1/4	3/16	16TSD7	16TSDS7	16TSDF7	40	68	30.0
18	12 - 10	□ 12	18TSD12	18TSDS12	18TSDF12	32	69	24.0
	3/16 - 1/4	3/16	18TSD7	18TSDS7	18TSDF7	60	97	45.0
20	10	□ 12	20TSD12	20TSDS12	20TSDF12	40	91	30.0
	3/16 - 1/4	3/16	20TSD7	20TSDS7	20TSDF7	67	118	50.25
24	10	□ 12	24TSD12	24TSDS12	24TSDF12	52	116	39.0
	3/16 - 1/4	3/16	24TSD7	24TSDS7	24TSDF7	87	151	65.25

□ Standard Gauge Bolt Patterns on page H-42

Discharge Gates



Rack and Pinion Flat Slide

Flat rack and pinion slide gates can be bolted to standard discharge spouts at any of the four positions desired. Hand wheel is normally furnished but is also available with chain or rope wheel.

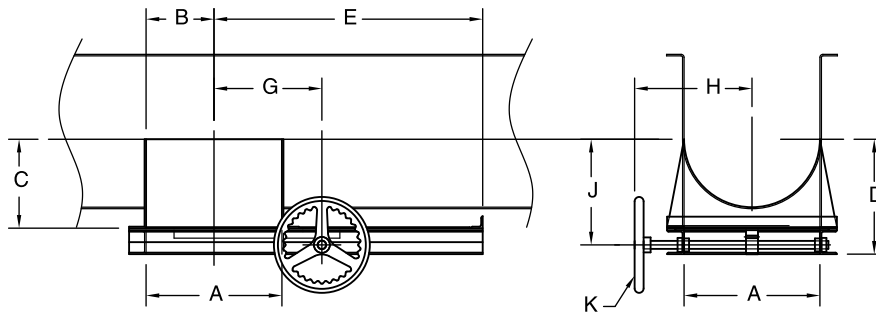

Screw Diameter	A	B	C	D	E	G	H	J	K Diameter
4	5	2 1/2	3 3/4	7	13 1/2	6 1/2	5	5 1/2	12
6	7	3 1/2	5	8 1/4	16	7 1/2	6	6 3/4	12
9	10	5	7 1/8	10 3/8	20 1/4	9	9 1/2	8 7/8	12
10	11	5 1/2	7 7/8	11 1/8	23 1/2	10 1/2	10	9 7/8	12
12	13	6 1/2	8 7/8	12 1/8	25 1/2	11	12 1/4	10 7/8	12
14	15	7 1/2	10 1/8	13 3/8	31 1/4	12 1/2	13 1/4	12	12
16	17	8 1/2	11 1/8	14 3/8	33 5/8	13 1/2	14 1/4	13	12
18	19	9 1/2	12 3/8	15 5/8	37 7/8	14 1/2	15 3/4	14 1/8	12
20	21	10 1/2	13 3/8	16 11/16	40 3/4	15 1/2	16 3/4	15 1/8	12
24	25	12 1/2	15 3/8	18 11/16	46 1/2	17 1/2	18 3/4	17 3/8	12

Screw Diameter	Trough Thickness Gauge	Spout and Gate Thickness Gauge	Part Number Rack and Pinion †	Weight Rack and Pinion
4	16 - 14	□ 14	4RPF14	18
	12	12	4RPF12	21
6	16 - 14 - 12	□ 14	6RPF14	28
	3/16	12	6RPF12	31
9	14 - 12 - 10	□ 14	9RPF14	49
	3/16 - 1/4	10	9RPF10	54
10	14 - 12 - 10	□ 14	10RPF14	56
	3/16 - 1/4	10	10RPF10	62
12	12 - 10	□ 12	12RPF12	94
	3/16 - 1/4	3/16	12RPF7	106
14	12 - 10	□ 12	14RPF12	107
	3/16 - 1/4	3/16	14RPF7	123
16	12 - 10	□ 12	16RPF12	112
	3/16 - 1/4	3/16	16RPF7	131
18*	12 - 10	□ 12	18RPF12	157
	3/16 - 1/4	3/16	18RPF7	185
20*	10	□ 12	20RPF12	185
	3/16 - 1/4	3/16	20RPF7	212
24*	10	□ 12	24RPF12	233
	3/16 - 1/4	3/16	24RPF7	268

- Standard Gauge Bolt Patterns on page H-42
- * Hand Wheels supplied as Standard Assembly
- C Chain Wheel
- R Rope Wheel
- † All Rack and Pinion Gates 18" and Larger Have Double Rack and Pinion

Rack and Pinion Curved Slide

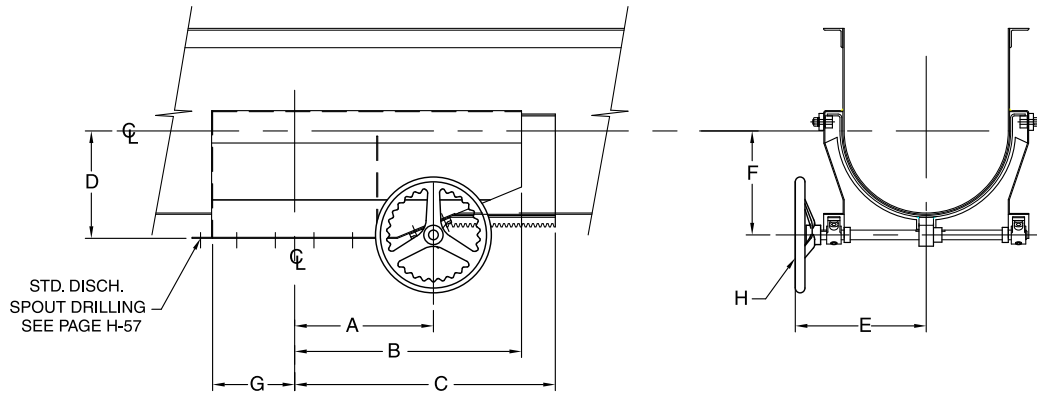

Screw Diameter	Trough Thickness	Spout Thickness	Part Number*	Weight	A	B	C	D	E	F	G	H Diameter
4	14,16 GA.	□ 14 GA.	4RPC14	20	6 1/4	8 3/4	12	3 3/4	6	4 1/2	2 1/2	12
	12 GA.	12 GA.	4RPC12	22						4 5/8		
6	16,14,12 GA.	□ 14 GA.	6RPC14	25	7 1/2	10 1/2	15	5	8	5 1/2	3 1/2	12
	3/16	12 GA.	6RPC12	28						5 5/8		
9	14,12,10 GA.	□ 14 GA.	9RPC14	46	9	15	20 1/2	7 1/8	8 3/4	7	5	12
	3/16,1/4	10 GA.	9RPC10	54						7 1/8		
10	14,12,10 GA.	□ 14 GA.	10RPC14	53	9 1/2	14 1/2	21	7 7/8	9 1/8	7 1/2	5 1/2	12
	3/16,1/4	10 GA.	10RPC10	62						7 5/8		
12	12,10 GA.	□ 12 GA.	12RPC12	81	11 3/8	17 1/2	25 3/4	8 7/8	11	8 1/2	6 1/2	12
	3/16,1/4	3/16	12RPC7	97						8 5/8		
14	10,12 GA.	□ 12 GA.	14RPC12	95	12 7/8	20 1/2	30 1/4	10 1/8	12	9 1/2	7 1/2	12
	3/16,1/4	3/16	14RPC7	114						9 5/8		
16	10,12 GA.	□ 12 GA.	16RPC12	103	14 3/8	23 1/2	36	11 1/8	13	10 1/2	8 1/2	12
	3/16,1/4	3/16	16RPC7	116						10 5/8		
18*	10,12 GA.	□ 12 GA.	18RPC12	157	15 7/8	25 1/2	37 1/4	12 3/8	15 3/8	11 1/2	9 1/2	12
	3/16,1/4	3/16	18RPC7	187						11 5/8		
20*	12 GA.	□ 12 GA.	20RPC12	175	17 3/8	28 1/2	39	13 3/8	16 3/8	12 1/2	10 1/2	12
	3/16,1/4	3/16	20RPC7	208						12 5/8		
24*	10 GA.	□ 12 GA.	24RPC12	220	19 3/8	35 1/2	47	15 3/8	18 3/8	14 1/2	12 1/2	12
	3/16,1/4	3/16	24RPC7	265						14 5/8		

□ Standard Gauge Bolt Patterns on page H-42

* Hand Wheels supplied as Standard Assembly

- C Chain Wheel

- R Rope Wheel

Discharge Gates



Dust Tight Rack and Pinion Flat Slide

Dust tight rack and pinions are totally enclosed and can be furnished with either flat or curved slide. Hand Wheel is normally furnished but is also available with chain or rope wheel.

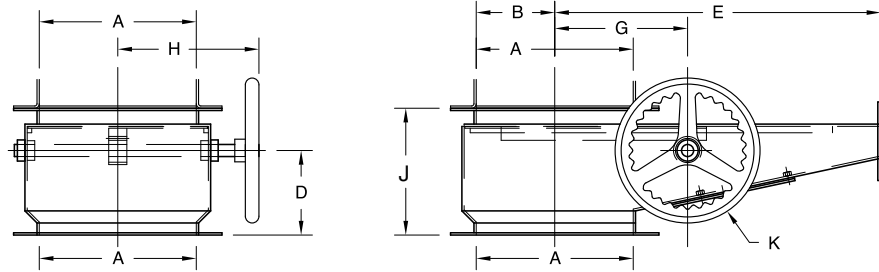

Dust Tight Rack and Pinion Curved Slide

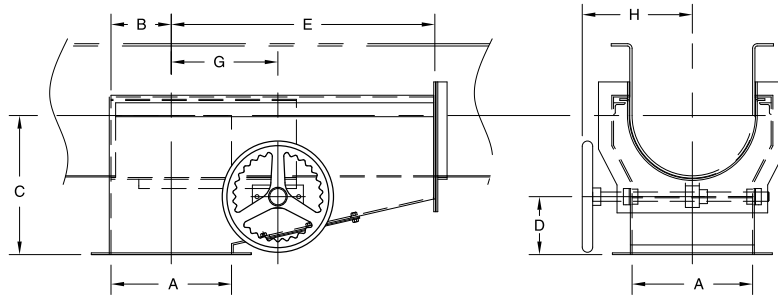

Screw Diameter	A	B	C	D	E	G	H	J	K Diameter
4	5	2 1/2	7 1/2	2 1/2	12	6	7	7 1/2	12
6	7	3 1/2	10	4	18 1/2	7 1/2	8	9	12
9	10	5	12 1/2	5	23	9	11	10	12
10	11	5 1/2	13	5	25	10	11 1/2	10 1/2	12
12	13	6 1/2	15	5	28	11 1/2	13	10 1/2	12
14	15	7 1/2	15 1/2	5 1/2	31	12 1/2	14	10 1/2	12
16	17	8 1/2	16 1/2	5 1/2	34	13 1/2	15	10 1/2	12
18	19	9 1/2	18 1/2	6 1/2	38 1/2	15	16 1/2	11 1/2	12
20	21	10 1/2	20	7	40 1/2	16	17 1/2	12	12
24	25	12 1/2	23	8	47 1/2	18	19 1/2	13	12

Screw Diameter	Trough Thickness Gauge	Spout and Gate Thickness Gauge	Part Number			
			Flat Slide *	Weight	Curved Slide *	Weight
4	16 - 14	14	4RPF14	27	4RPCD16	30
	12	12	4RPF12	32	4RPCD12	35
6	16 - 14 - 12	14	6RPF14	42	6RPCD16	46
	3/16	12	6RPF12	47	6RPCD12	52
9	14 - 12 - 10	14	9RPF12	74	9RPCD12	81
	3/16 - 1/4	10	9RPF10	81	9RPCD10	89
10	14 - 12 - 10	14	10RPF14	84	10RPCD14	92
	3/16 - 1/4	10	10RPF10	93	10RPCD10	102
12	12 - 10	12	12RPF12	141	12RPCD12	155
	3/16 - 1/4	3/16	12RPF7	158	12RPCD7	174
14	12 - 10	12	14RPF12	160	14RPCD12	176
	3/16 - 1/4	3/16	14RPF7	185	14RPCD7	204
16	12 - 10	12	16RPF12	168	16RPCD12	185
	3/16 - 1/4	3/16	16RPF7	197	16RPCD7	217
18	12 - 10	12	18RPF12	240	18RPCD12	264
	3/16 - 1/4	3/16	18RPF7	277	18RPCD7	305
20	10	12	20RPF12	278	20RPCD12	306
	3/16 - 1/4	3/16	20RPF7	318	20RPCD7	350
24	10	12	24RPF12	350	24RPCD12	385
	3/16 - 1/4	3/16	24RPF7	402	24RPCD7	442

* Hand Wheels supplied as Standard Assembly

- C Chain Wheel
- R Rope Wheel

Flange drilling in standard. See page H-43

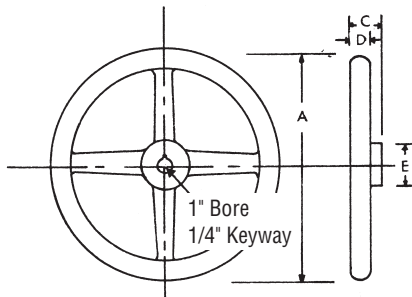

Hand Wheel

Wheel Diameter	Part Number	Weight	C	D	E
12	12HW1	11	2	1 1/8	1 7/8

The hand wheel is regularly furnished to rotate the pinion shaft when the slide gate is readily accessible.

NOTE: Zinc or nickel plated hand wheels available on request.

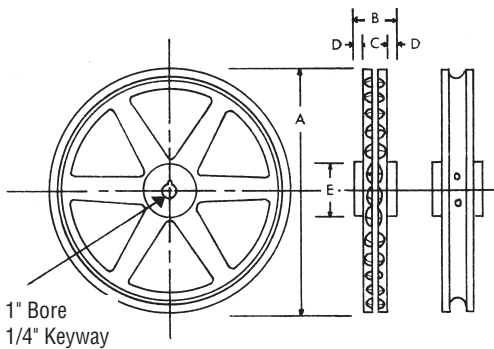

Pocket Chain Wheel & Rope Wheel

Wheel	Part Number	Weight	A	B	C	D	E
Chain Wheel	20PW1	11	12 3/4	2	1 3/8	5/16	2
Rope Wheel	12RW1	13	12 5/8	2 1/4	1 5/8	1 1/4	1 7/8

Pocket chain and rope wheels are used to rotate pinion shaft where remote operation is desired. It is designed to be used with number 3/16 pocket chain.

NOTE:

Zinc or nickel plated hand wheels available on request.

316 PC Pocket Chain in Stock.

Hanger Pockets

Hanger pockets are used with tubular trough and are mounted on the trough at bearing connections. The hanger pocket forms a "U" shaped section for a short distance, allowing the use of standard hangers and providing easy access to them.

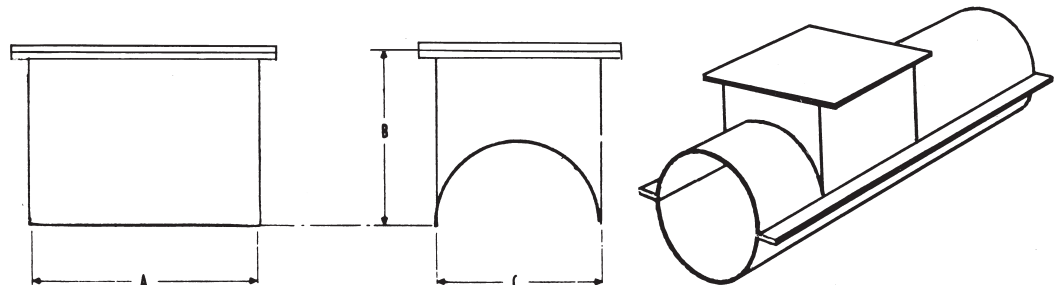

Conveyor Diameter	Part Number	A	B	C	Weight Each
4	4CPH16	8	3 3/4	5	2
6	6CPH16	12	4 3/4	7	3
9	9CPH14	12	6 3/8	10	4
10	10CPH14	12	6 5/8	11	9
12	12CPH12	18	8	13	18
14	14CPH12	18	9 1/2	15	24
16	16CPH12	18	10 7/8	17	26
18	18CPH12	18	12 3/8	19	55
20	20CPH10	18	13 3/4	21	70
24	24CPH10	18	16 3/4	25	85

Trough Ends



Trough Ends					
		9	TEF	3	-BB -P
	Conveyor Diameter	Type		Bearing Type	Plate Only
		TE — Outside W/O Feet TEF — Outside W/Feet TEI — Inside TER — Inside Rectangular TEO — Single Bearing Pedestal TEOD — Double Bearing Pedestal FTEF — Outside Flared W/Feet FTE — Outside Flared W/O Feet FTEO — Single Bearing Flared Pedestal FTDO — Flared Discharge End TDO — Outside Discharge End TDI — Inside Discharge End CHTE — Outside Tubular W/O Feet CHTEF — Outside Tubular W/Feet SCD — Dorris Screw Drive		BB - Ball RB - Roller BR - Bronze	
				Coupling Diameter	
				2 — 1"	5 — 2-7/16"
				3 — 1-1/2"	6 — 3"
				4 — 2"	7 — 3-7/16"
	U-TROUGH	TUBULAR TROUGH	FLARED TROUGH	RECTANGULAR TROUGH	
OUTSIDE TROUGH ENDS WITH FEET					Most common type used as trough support is included
OUTSIDE TROUGH ENDS WITHOUT FEET					Trough support not included
INSIDE PATTERN TROUGH ENDS		Available on application	Available on application		Used where space is limited or trough does not have end flange
DISCHARGE TROUGH ENDS		Available on application			For end discharge conveyors. Special flange bearing required
OUTBOARD BEARING TROUGH END SINGLE					Used when compression type packing gland seal or split gland seal required

Outside Less Feet

Outside trough ends less feet are used to support end bearing and cover when no trough support is required. Drilling for bronze bearing or flanged ball bearing is standard.

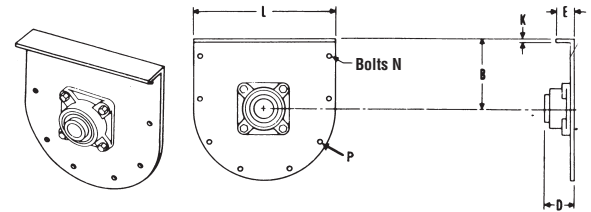

Conveyor Diameter	Shaft Diameter	▲ Part Number	B	D			E	K	L	N	Weight	P Slot
				Friction Bearing	Ball Bearing	Roller Bearing						
4	1	4TE2-*	3 5/8	2 3/16	1 5/8	—	1 7/16	1/4	8 1/8	3/8	3	7/16 × 9/16
6	1 1/2	6TE3-*	4 1/2	3 3/16	2 3/16	3 11/16	1 1/2	1/4	10 1/8	3/8	4	7/16 × 9/16
9	1 1/2	9TE3-*	6 1/8	3 1/4	2 3/16	3 11/16	1 5/8	1/4	13 3/4	3/8	9	7/16 × 9/16
	2	9TE4-*	6 1/8	4 1/4	2 1/2	3 13/16	1 5/8	1/4	13 3/4	3/8	9	
10	1 1/2	10TE3-*	6 3/8	3 1/4	2 3/16	3 11/16	1 3/4	1/4	14 3/4	3/8	11	7/16 × 9/16
	2	10TE4-*	6 3/8	4 1/4	2 1/2	3 13/16	1 3/4	1/4	14 3/4	3/8	11	
12	2	12TE4-*	7 3/4	4 1/4	2 9/16	3 7/8	2	1/4	17 1/4	1/2	20	9/16 × 11/16
	2 7/16	12TE5-*	7 3/4	5 1/4	2 15/16	4 7/16	2	1/4	17 1/4	1/2	20	
	3	12TE6-*	7 3/4	6 1/4	3 3/4	4 15/16	2	1/4	17 1/4	1/2	20	
14	2 7/16	14TE5-*	9 1/4	5 5/16	2 15/16	4 7/16	2	1/4	19 1/4	1/2	35	9/16 × 11/16
	3	14TE6-*	9 1/4	5 5/16	3 3/4	4 15/16	2	1/4	19 1/4	1/2	35	
16	3	16TE6-*	10 5/8	6 5/16	3 13/16	5	2 1/2	5/16	21 1/4	5/8	42	11/16 × 13/16
18	3	18TE6-*	12 1/8	6 3/8	3 13/16	5	2 1/2	3/8	24 1/4	5/8	60	11/16 × 13/16
	3 7/16	18TE7-*	12 1/8	7 3/8	4 5/16	5 9/16	2 1/2	3/8	24 1/4	5/8	60	
20	3	20TE6-*	13 1/2	6 3/8	3 7/8	5 1/16	2 1/2	3/8	26 1/4	5/8	90	11/16 × 13/16
	3 7/16	20TE7-*	13 1/2	7 3/8	4 3/8	5 5/8	2 1/2	3/8	26 1/4	5/8	90	
24	3 7/16	24TE7-*	16 1/2	7 3/8	4 3/8	5 5/8	2 1/2	3/8	30 1/4	5/8	120	11/16 × 13/16

Outside With Feet

Outside trough ends with feet are used to support end bearing, cover and trough. Drilling for bronze or flanged ball bearing is standard.

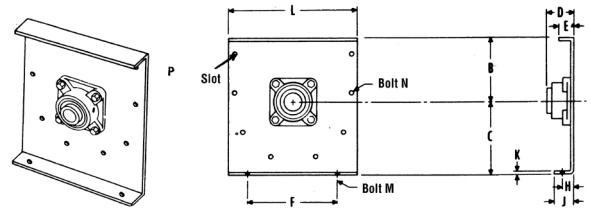

Conveyor Diameter	Shaft Diameter	▲ Part Number	B	C	D			E	F	H	J	K	L	M	N	Weight	P Slot
					Friction Bearing	Ball Bearing	Roller Bearing										
4	1	4TEF2-*	3 5/8	4 5/8	2 15/16	1 5/8	—	1 7/16	5 3/4	1	1 5/8	1/4	8 1/8	3/8	3/8	4	7/16 × 9/16
6	1 1/2	6TEF3-*	4 1/2	5 5/8	3 15/16	2 3/16	3 11/16	1 1/2	8 1/8	1	1 3/4	1/4	10 1/8	3/8	3/8	7	7/16 × 9/16
9	1 1/2	9TEF3-*	6 1/8	7 7/8	3 15/16	2 3/16	3 11/16	1 5/8	9 3/8	1 1/2	2 5/8	1/4	13 3/4	1/2	3/8	12	7/16 × 9/16
	2	9TEF4-*	6 1/8	7 7/8	4 15/16	2 1/2	3 13/16	1 5/8	9 3/8	1 1/2	2 5/8	1/4	13 3/4	1/2	3/8	12	
10	1 1/2	10TEF3-*	6 3/8	8 7/8	3 15/16	2 3/16	3 11/16	1 3/4	9 1/2	1 3/4	2 7/8	1/4	14 3/4	1/2	3/8	14	7/16 × 9/16
	2	10TEF4-*	6 3/8	8 7/8	4 15/16	2 1/2	3 13/16	1 3/4	9 1/2	1 3/4	2 7/8	1/4	14 3/4	1/2	3/8	14	
12	2	12TEF4-*	7 3/4	9 5/8	5	2 9/16	3 7/8	2	12 1/4	1 5/8	2 3/4	1/4	17 1/4	5/8	1/2	23	9/16 × 11/16
	2 7/16	12TEF5-*	7 3/4	9 5/8	5 1/2	2 15/16	4 7/16	2	12 1/4	1 5/8	2 3/4	1/4	17 1/4	5/8	1/2	23	
	3	12TEF6-*	7 3/4	9 5/8	5 5/8	3 3/4	4 15/16	2	12 1/4	1 5/8	2 3/4	1/4	17 1/4	5/8	1/2	23	
14	2 7/16	14TEF5-*	9 1/4	10 7/8	5 1/2	2 15/16	4 7/16	2	13 1/2	1 5/8	2 7/8	1/4	19 1/4	5/8	1/2	38	9/16 × 11/16
	3	14TEF6-*	9 1/4	10 7/8	5 5/8	3 3/4	4 15/16	2	13 1/2	1 5/8	2 7/8	1/4	19 1/4	5/8	1/2	38	
16	3	16TEF6-*	10 5/8	12	5 11/16	3 13/16	5	2 1/2	14 7/8	2	3 1/4	5/16	21 1/4	5/8	5/8	45	11/16 × 13/16
18	3	18TEF6-*	12 1/8	13 3/8	5 11/16	3 13/16	5	2 1/2	16	2	3 1/4	3/8	24 1/4	5/8	5/8	67	11/16 × 13/16
	3 7/16	18TEF7-*	12 1/8	13 3/8	6 15/16	4 5/16	5 9/16	2 1/2	16	2	3 1/4	3/8	24 1/4	5/8	5/8	67	
20	3	20TEF6-*	13 1/2	15	5 3/4	3 7/8	5 1/16	2 1/2	19 1/4	2 1/4	3 3/4	3/8	26 1/4	3/4	5/8	120	11/16 × 13/16
	3 7/16	20TEF7-*	13 1/2	15	7	4 3/8	5 5/8	2 1/2	19 1/4	2 1/4	3 3/4	3/8	26 1/4	3/4	5/8	120	
24	3 7/16	24TEF7-*	16 1/2	18 1/8	7	4 3/8	5 5/8	2 1/2	20	2 1/2	4 1/8	3/8	30 1/4	3/4	5/8	162	11/16 × 13/16

▲ Can be furnished with CSP, CSW, or CSFP seals

—*BB Ball Bearing
—*BR Bronze Bearing

—*RB Roller Bearing
—*P Less Bearing

Trough Ends



Inside

Inside trough ends are used in place of outside type where no trough end flanges are required. Drilling for bronze bearings or flanged ball bearing is standard.

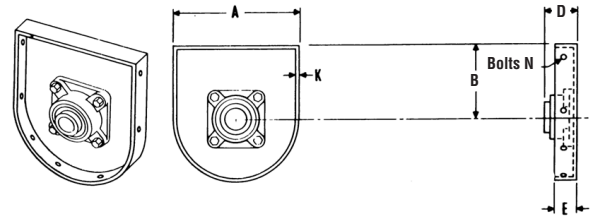

Conveyor Diameter	Shaft Diameter	▲ Part Number	A	B	D			E	K	N	Weight
					Friction Bearing	Ball Bearing	Roller Bearing				
4	1	4TEI2-*	5	3 5/8	2 3/16	1 5/8	—	2	1/4	1/4	3
6	1 1/2	6TEI3-*	7	4 1/2	3 3/16	2 3/16	3 11/16	2	1/4	5/16	5
9	1 1/2	9TEI3-*	10	6 1/8	3 1/4	2 3/16	3 11/16	2	1/4	3/8	9
	2	9TEI4-*	10	6 1/8	4 1/4	2 1/2	3 13/16	2	1/4	3/8	9
10	1 1/2	10TEI3-*	11	6 3/8	3 1/4	2 3/16	3 11/16	2	1/4	3/8	11
	2	10TEI4-*	11	6 3/8	4 1/4	2 1/2	3 13/16	2	1/4	3/8	11
12	2	12TEI4-*	13	7 3/4	4 1/4	2 9/16	3 7/8	2	1/4	1/2	19
	2 7/16	12TEI5-*	13	7 3/4	5 1/4	2 15/16	4 7/16	2	1/4	1/2	19
	3	12TEI6-*	13	7 3/4	6 1/4	3 3/4	4 15/16	2	1/4	1/2	19
14	2 7/16	14TEI5-*	15	9 1/4	5 5/16	2 15/16	4 7/16	2	1/4	1/2	34
	3	14TEI6-*	15	9 1/4	6 5/16	3 3/4	4 15/16	2	1/4	1/2	34
16	3	16TEI6-*	17	10 5/8	6 5/16	3 13/16	5	2	5/16	5/8	40
	3	18TEI6-*	19	12 1/8	6 3/8	3 13/16	5	2	3/8	5/8	58
18	3 7/16	18TEI7-*	19	12 1/8	7 3/8	4 5/16	5 9/16	2	3/8	5/8	58
	3	20TEI6-*	21	13 1/2	6 3/8	3 7/8	5 1/16	2	3/8	5/8	83
20	3 7/16	20TEI7-*	21	13 1/2	7 3/8	4 3/8	5 5/8	2	3/8	5/8	83
	3 7/16	24TEI7-*	25	16 1/2	7 3/8	4 3/8	5 5/8	2	3/8	5/8	116

Inside Rectangular

Rectangular trough ends are used inside of rectangular trough. Drilling for bronze bearing or flanged ball bearing is standard

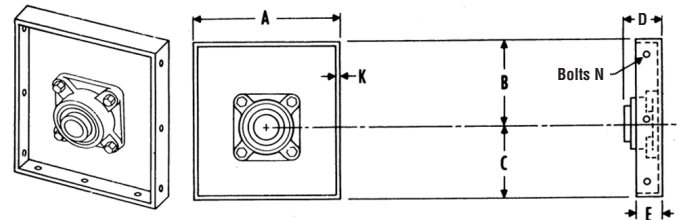

Conveyor Diameter	Shaft Diameter	▲ Part Number	A	B	C	D			E	K	N	Weight
						Friction Bearing	Ball Bearing	Roller Bearing				
4	1	4TER2-*	5	3 5/8	2 1/2	2 3/16	1 5/8	—	2	1/4	1/4	4
6	1 1/2	6TER3-*	7	4 1/2	3 1/2	3 3/16	2 3/16	3 11/16	2	1/4	5/16	6
9	1 1/2	9TER3-*	10	6 1/8	5	3 1/4	2 3/16	3 11/16	2	1/4	3/8	9
	2	9TER4-*	10	6 1/8	5	4 1/4	2 1/2	3 13/16	2	1/4	3/8	9
10	1 1/2	10TER3-*	11	6 3/8	5 1/2	3 1/4	2 3/16	3 11/16	2	1/4	3/8	12
	2	10TER4-*	11	6 3/8	5 1/2	4 1/4	2 1/2	3 13/16	2	1/4	3/8	12
12	2	12TER4-*	13	7 3/4	6 1/2	4 1/4	2 9/16	3 7/8	2	1/4	1/2	21
	2 7/16	12TER5-*	13	7 3/4	6 1/2	5 1/4	2 15/16	4 7/16	2	1/4	1/2	21
	3	12TER6-*	13	7 3/4	6 1/2	6 1/4	3 3/4	4 15/16	2	1/4	1/2	21
14	2 7/16	14TER5-*	15	9 1/4	7 1/2	5 5/16	2 15/16	4 7/16	2	1/4	1/2	35
	3	14TER6-*	15	9 1/4	7 1/2	6 5/16	3 3/4	4 15/16	2	1/4	1/2	35
16	3	16TER6-*	17	10 5/8	8 1/2	6 5/16	3 13/16	5	2	5/16	5/8	41
18	3	18TER6-*	19	12 1/8	9 1/2	6 3/8	3 13/16	5	2	3/8	5/8	60
	3 7/16	18TER7-*	19	12 1/8	9 1/2	7 3/8	4 5/16	5 9/16	2	3/8	5/8	60
20	3	20TER6-*	21	13 1/2	10 1/2	6 3/8	3 7/8	5 1/16	2	3/8	5/8	88
	3 7/16	20TER7-*	21	13 1/2	10 1/2	7 3/8	4 3/8	5 5/8	2	3/8	5/8	88
24	3 7/16	24TER7-*	25	16 1/2	12 1/2	7 3/8	4 3/8	5 5/8	2	3/8	5/8	125

▲ Can be furnished with CSP, CSW, or CSFP seals

-*BB Ball Bearing
-*BR Bronze Bearing

-*RB Roller Bearing
-*PLess Bearing

Single Bearing

Single bearing pedestal type trough ends are constructed with base for mounting pillow block bearings and shaft seal or packing gland.

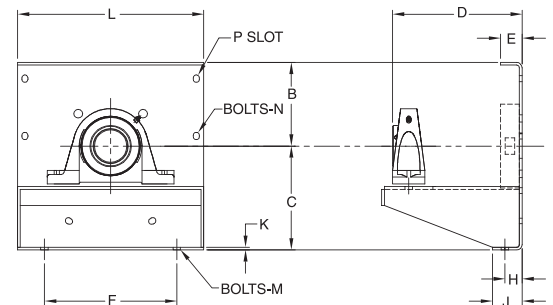

Conveyor Diameter	Shaft Diameter	Part Number	B	C	D	E	F	H	J	K	L	M	N	P Slot	Weight
6	1 1/2	6TE03	Consult Factory												
9	1 1/2	9TE03													
	2	9TE04													
10	1 1/2	10TE03													
	2	10TE04													
12	2 7/16	12TE04													
	3	12TE05													
		12TE06													
14	2 7/16	14TE05													
	3	14TE06													
16	3	16TE06													
18	3	18TE06													
	3 7/16	18TE07													
20	3	20TE06													
	3 7/16	20TE07													
24	3 7/16	24TE07													

Double Bearing

Double bearing pedestal type trough ends are for use with pillow block bearing in conjunction with a flanged bearing providing extra shaft support.

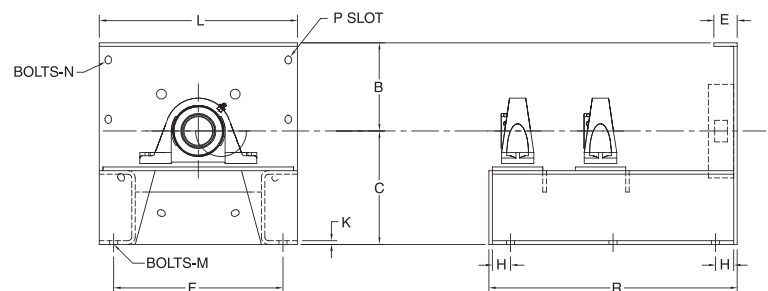

Conveyor Diameter	Shaft Diameter	Part Number	B	C	E	F	H	K	L	M	R	P Slot	Weight
6	1 1/2	6TEOD3	Consult Factory										
9	1 1/2	9TEOD3											
	2	9TEOD4											
10	1 1/2	10TEOD3											
	2	10TEOD4											
12	2 7/16	12TEOD4											
	3	12TEOD5											
		12TEOD6											
14	2 7/16	14TEOD5											
	3	14TEOD6											
16	3	16TEOD6											
18	3	18TEOD6											
	3 7/16	18TEOD7											
20	3	20TEOD6											
	3 7/16	20TEOD7											
24	3 7/16	24TEOD7											

Trough Ends

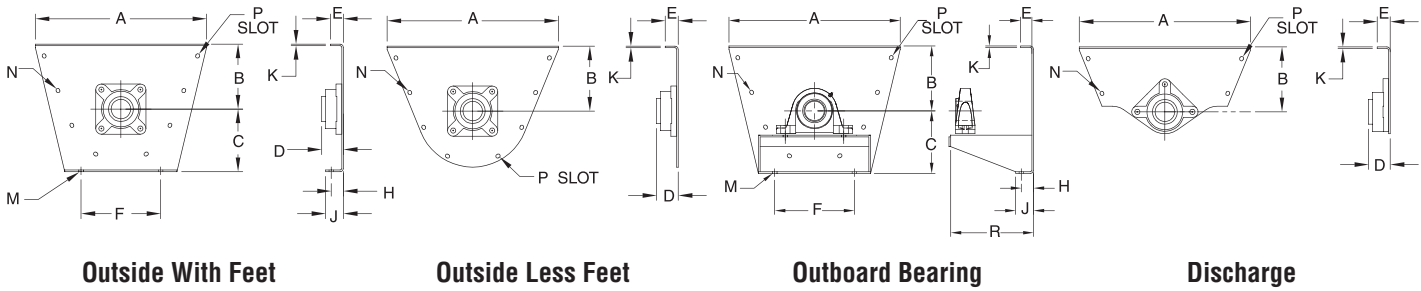

Application: same as standard trough ends except for flared trough.

Conveyor Diameter	Shaft Diameter	A	B	C	D			E	F	H	J	K	M	N	R	P Slot
					Friction Bearing	Ball Bearing	Roller Bearing									
6	1 1/2	16 5/8	7	5 5/8	3 3/16	2 3/16	3 3/4	1 1/2	8 1/8	1	1 3/4	1/4	3/8	3/8		7/16 x 9/16
9	1 1/2	21 1/4	9	7 7/8	3 1/4	2 3/16	3 3/4	1 5/8	9 3/8	1 1/2	2 5/8	1/4	1/2	3/8		7/16 x 9/16
	2	21 1/4	9	7 7/8	4 1/4	2 1/2	3 7/8	1 5/8	9 3/8	1 1/2	2 5/8	1/4	1/2	3/8		7/16 x 9/16
12	2	26 3/8	10	9 5/8	4 1/4	2 9/16	3 7/8	2	12 1/4	1 5/8	2 3/4	1/4	5/8	1/2		9/16 x 11/16
	2 7/16	26 3/8	10	9 5/8	5 1/4	2 15/16	4 1/2	2	12 1/4	1 5/8	2 3/4	1/4	5/8	1/2		9/16 x 11/16
14	3	26 3/8	10	9 5/8	6 1/4	3 3/4	5	2	12 1/4	1 5/8	2 3/4	1/4	5/8	1/2		9/16 x 11/16
	2 7/16	28 3/8	11	10 7/8	5 5/16	2 15/16	4 1/2	2	13 1/2	1 5/8	2 7/8	1/4	5/8	1/2		9/16 x 11/16
16	3	28 3/8	11	10 7/8	6 5/16	3 3/4	5	2	13 1/2	1 5/8	2 7/8	5/16	5/8	1/2		9/16 x 11/16
	3	32 1/2	11 1/2	12	6 5/16	3 13/16	5	2 1/2	14 7/8	2	3 1/4	5/16	5/8	5/8		11/16 x 13/16
18	3	36 1/2	12 1/8	13 3/8	6 3/8	3 13/16	5	2 1/2	16	2	3 1/4	3/8	5/8	5/8		11/16 x 13/16
	3 7/16	36 1/2	12 1/8	13 3/8	7 3/8	4 5/16	5 5/8	2 1/2	16	2	3 1/4	3/8	5/8	5/8		11/16 x 13/16
20	3	39 1/2	13 1/2	15	6 3/8	3 7/8	5	2 1/2	19 1/4	2 1/4	3 3/4	3/8	3/4	5/8		11/16 x 13/16
	3 7/16	39 1/2	13 1/2	15	7 3/8	4 3/8	5 5/8	2 1/2	19 1/4	2 1/4	3 3/4	3/8	3/4	5/8		11/16 x 13/16
24	3 7/16	45 1/2	16 1/2	18 1/8	7 3/8	4 3/8	5 5/8	2 1/2	20	2 1/2	4 1/8	3/8	3/4	5/8		11/16 x 13/16

Consult Factory

Conveyor Diameter	Shaft Diameter	Part Number							
		Outside With Feet	Weight	Outside Less Feet	Weight	Outboard Bearing	Weight	Discharge	Weight
6	1 1/2	6FTEF3-*	15	6FTE3-*	13	6FTE03-*	22	6FTD03-**	11
9	1 1/2	9FTEF3-*	22	9FTE3-*	19	9FTE03-*	31	9FTD03-**	15
	2	9FTEF4-*	27	9FTE4-*	24	9FTE04-*	36	9FTD04-**	20
12	2	12FTEF4-*	43	12FTE4-*	36	12FTE04-*	63	12FTD04-**	28
	2 7/16	12FTEF5-*	44	12FTE5-*	37	12FTE05-*	64	12FTD05-**	29
14	3	12FTEF6-*	56	12FTE6-*	49	12FTE06-*	76	12FTD06-**	41
	2 7/16	14FTEF5-*	52	14FTE5-*	43	14FTE05-*	75	14FTD05-**	33
16	3	14FTEF6-*	64	14FTE6-*	55	14FTE06-*	87	14FTD06-**	45
	3	16FTEF6-*	85	16FTE6-*	72	16FTE06-*	125	16FTD06-**	56
18	3	18FTEF6-*	98	18FTE6-*	83	18FTE06-*	138	18FTD06-**	63
	3 7/16	18FTEF7-*	104	18FTE7-*	89	18FTE07-*	144	18FTD07-**	69
20	3	20FTEF6-*	133	20FTE6-*	103	20FTE06-*	196	20FTD06-**	75
	3 7/16	20FTEF7-*	139	20FTE7-*	109	20FTE07-*	202	20FTD07-**	81
24	3 7/16	24FTEF7-*	179	24FTE7-*	132	24FTE07-*	250	24FTD07-**	96

-*BB-P Ball Bearing Plate Only
-*RB-P Roller Bearing Plate Only

For Bolt Pattern see Page H-41

Outside Discharge

Outside discharge trough ends are used to support end bearing and will allow material to discharge or overflow through the end of the trough. Drilling for three bolt bronze or flanged ball bearing is standard.

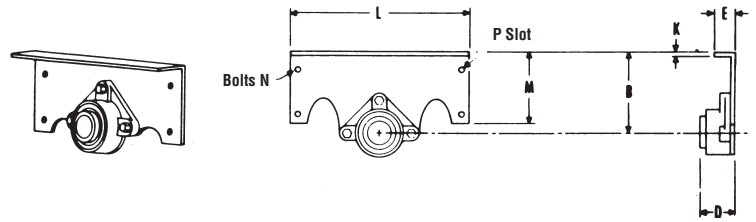

Conveyor Diameter	Shaft Diameter	Part Number	B	D			E	K	L	M	N	P Slot	Weight
				Friction Bearing	Ball Bearing	Roller Bearing							
4	1	4TD02-*	3 5/8	2 1/4	1 5/8		1 7/16	1/4	8	3 5/8	3/8	7/16 × 9/16	2
6	1 1/2	6TD03-*	4 1/2	3 1/2	2 1/8	3 3/4	1 1/2	1/4	9 3/4	4 1/2	3/8	7/16 × 9/16	3
9	1 1/2	9TD03-*	6 1/8	3 1/2	2 1/8	3 3/4	1 5/8	1/4	13 3/4	6 1/8	3/8	7/16 × 9/16	5
	2	9TD04-*	6 1/8	4 7/16	2 1/2	3 7/8	1 5/8	1/4	13 3/4	6 1/8	3/8	7/16 × 9/16	5
10	1 1/2	10TD03-*	6 3/8	3 1/2	2 1/8	3 3/4	1 3/4	1/4	14 3/4	6 3/8	3/8	7/16 × 9/16	6
	2	10TD04-*	6 3/8	4 7/16	2 1/2	3 7/8	1 3/4	1/4	14 3/4	6 3/8	3/8	7/16 × 9/16	6
12	2	12TD04-*	7 3/4	4 7/16	2 1/2	3 7/8	2	1/4	17 1/4	7 3/4	1/2	9/16 × 11/16	12
	2 7/16	12TD05-*	7 3/4	5 5/16	2 9/16	4 7/16	2	1/4	17 1/4	7 3/4	1/2	9/16 × 11/16	12
	3	12TD06-*	7 3/4	5 15/16	3 3/4	4 15/16	2	1/4	17 1/4	7 3/4	1/2	9/16 × 11/16	12
14	2 7/16	14TD05-*	9 1/4	5 5/16	2 9/16	4 7/16	2	1/4	19 1/4	9 1/4	1/2	9/16 × 11/16	17
	3	14TD06-*	9 1/4	5 15/16	3 3/8	4 15/16	2	1/4	19 1/4	9 1/4	1/2	9/16 × 11/16	17
16	3	16TD06-*	10 5/8	6	3 7/16	5	2 1/2	5/16	21 1/4	10 5/8	5/8	11/16 × 13/16	26
18	3	18TD06-*	12 1/8	6 1/16	3 1/2	5 1/16	2 1/2	3/8	24 1/4	12 1/8	5/8	11/16 × 13/16	33
	3 7/16	18TD07-*	12 1/8	6 5/8	3 3/4	5 5/8	2 1/2	3/8	24 1/4	12 1/8	5/8	11/16 × 13/16	33
20	3	20TD06-*	13 1/2	6 1/16	3 1/2	5 1/16	2 1/2	3/8	26 1/4	13 1/2	5/8	11/16 × 13/16	55
	3 7/16	20TD07-*	13 1/2	6 5/8	3 3/4	5 5/8	2 1/2	3/8	26 1/4	13 1/2	5/8	11/16 × 13/16	55
24	3 7/16	24TD07-*	16 1/2	6 5/8	3 3/4	5 5/8	2 1/2	3/8	30 1/2	16 1/2	5/8	11/16 × 13/16	81

Inside Discharge

Inside discharge trough ends are used to support end bearing and will allow material to discharge or overflow through the end of the trough. This trough end is used inside the trough where no trough end flanges are required. Drilling for three bolt bronze or flanged ball bearing is standard.

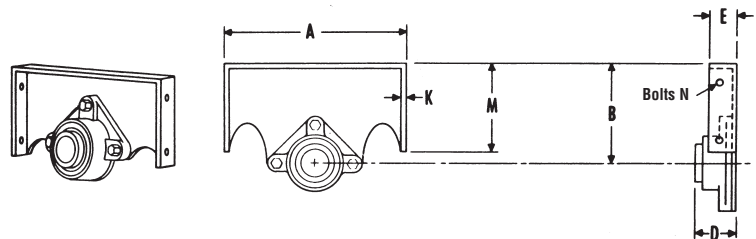

Conveyor Diameter	Shaft Diameter	Part Number	A	B	D			E	K	M	N	Weight
					Friction Bearing	Ball Bearing	Roller Bearing					
4	1	4TDI2-*	5	3 5/8	2 1/4	1 5/8		2	1/4	3 5/8	3/8	2
6	1 1/2	6TDI3-*	7	4 1/2	3 1/2	2 1/8	3 3/4	2	1/4	4 1/2	3/8	3
9	1 1/2	9TDI3-*	10	6 1/8	3 1/2	2 1/8	3 3/4	2	1/4	6 1/8	3/8	5
	2	9TDI4-*	10	6 1/8	4 7/16	2 1/2	3 7/8	2	1/4	6 1/8	3/8	5
10	1 1/2	10TDI3-*	11	6 3/8	3 1/2	2 1/8	3 3/4	2	1/4	6 3/8	3/8	6
	2	10TDI4-*	11	6 3/8	4 7/16	2 1/2	3 7/8	2	1/4	6 3/8	3/8	6
12	2	12TDI4-*	13	7 3/4	4 7/16	2 1/2	3 7/8	2	1/4	7 3/4	1/2	12
	2 7/16	12TDI5-*	13	7 3/4	5 5/16	2 9/16	4 7/16	2	1/4	7 3/4	1/2	12
	3	12TDI6-*	13	7 3/4	5 15/16	3 3/4	4 15/16	2	1/4	7 3/4	1/2	12
14	2 7/16	14TDI5-*	15	9 1/4	5 5/16	2 9/16	4 7/16	2	1/4	9 1/4	5/8	16
	3	14TDI6-*	15	9 1/4	5 15/16	3 3/8	4 15/16	2	1/4	9 1/4	5/8	16
16	3	16TDI6-*	17	10 5/8	6	3 7/16	5	2	5/16	10 5/8	5/8	25
18	3	18TDI6-*	19	12 1/8	6 1/16	3 1/2	5 1/16	2	3/8	12 1/8	5/8	32
	3 7/16	18TDI7-*	19	12 1/8	6 5/8	3 3/4	5 5/8	2	3/8	12 1/8	5/8	32
20	3	20TDI6-*	21	13 1/2	6 1/16	3 1/2	5 1/16	2	3/8	13 1/2	5/8	50
	3 7/16	20TDI7-*	21	13 1/2	6 5/8	3 3/4	5 5/8	2	3/8	13 1/2	5/8	50
24	3 7/16	24TDI7-*	25	16 1/2	6 5/8	3 3/4	5 5/8	2	3/8	16 1/2	5/8	76

-*BB-P Ball Bearing Plate Only
 -*RB-P Roller Bearing Plate Only

Trough Ends



Outside

Outside tubular trough ends less feet are used to support end bearings on tubular trough where no foot or support is required. Drilling for bronze or flanged ball bearing is standard.

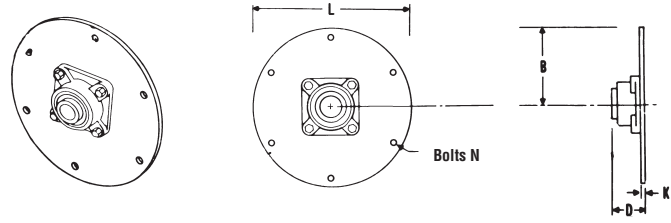

Conveyor Diameter	Shaft Diameter	Part Number	B	D			K	L	N	Weight
				Friction Bearing	Ball Bearing	Roller Bearing				
4	1	4CHTE2-*	4	2 1/4	1 5/8		1/4	8	3/8	2
6	1 1/2	6CHTE3-*	5 1/16	3 1/2	2 1/8	3 3/4	1/4	10 1/8	3/8	3
9	1 1/2	9CHTE3-*	6 5/8	3 1/2	2 1/8	3 3/4	1/4	13 1/4	3/8	6
	2	9CHTE4-*	6 5/8	4 7/16	2 1/2	3 7/8	1/4	13 1/4	3/8	6
10	1 1/2	10CHTE3-*	7 3/8	3 1/2	2 1/8	3 3/4	1/4	14 3/4	3/8	7
	2	10CHTE4-*	7 3/8	4 7/16	2 1/2	3 7/8	1/4	14 3/4	3/8	7
12	2	12CHTE4-*	8 1/8	4 7/16	2 1/2	3 7/8	1/4	16 1/4	1/2	13
	2 7/16	12CHTE5-*	8 1/8	5 5/16	2 9/16	4 7/16	1/4	16 1/4	1/2	13
	3	12CHTE6-*	8 1/8	5 15/16	3 3/4	4 15/16	1/4	16 1/4	1/2	13
14	2 7/16	14CHTE5-*	9 1/8	5 5/16	2 9/16	4 7/16	1/4	18 1/4	1/2	19
	3	14CHTE6-*	9 1/8	5 15/16	3 3/8	4 15/16	1/4	18 1/4	1/2	19
16	3	16CHTE6-*	10 5/8	6	3 7/16	5	5/16	21 1/4	5/8	29
18	3	18CHTE6-*	12 1/8	6 1/16	3 1/2	5 1/16	3/8	24 1/4	5/8	39
	3 7/16	18CHTE7-*	12 1/8	6 5/8	3 3/4	5 5/8	3/8	24 1/4	5/8	39
20	3	20CHTE6-*	13 1/8	6 1/16	3 1/2	5 1/16	3/8	26 1/4	5/8	63
	3 7/16	20CHTE7-*	13 1/8	6 5/8	3 3/4	5 5/8	3/8	26 1/4	5/8	63
24	3 7/16	24CHTE7-*	15 1/8	6 5/8	3 3/4	5 5/8	3/8	30 1/4	5/8	87

Outside with Feet

Outside tubular trough ends with feet are used to support end bearing where trough support is required. Drilling for bronze or flanged ball bearing is standard.

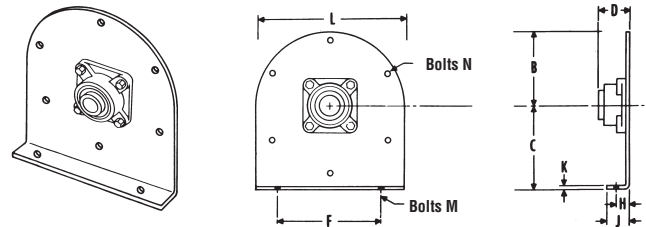

Conveyor Diameter	Shaft Diameter	Part Number	B	C	D			F	H	J	K	L	M	N	Weight
					Friction Bearing	Ball Bearing	Roller Bearing								
4	1	4CHTEF2-*	4	4 5/8	2 1/4	1 5/8		5 3/4	1	1 5/8	1/4	8	3/8	3/8	3
6	1 1/2	6CHTEF3-*	5 1/16	5 5/8	3 1/2	2 1/8	3 3/4	8 1/8	1	1 3/4	1/4	10 1/8	3/8	3/8	5
9	1 1/2	9CHTEF3-*	6 5/8	7 7/8	3 1/2	2 1/8	3 3/4	9 3/8	1 1/2	2 5/8	1/4	13 1/4	1/2	3/8	10
	2	9CHTEF4-*	6 5/8	7 7/8	4 7/16	2 1/2	3 7/8	9 3/8	1 1/2	2 5/8	1/4	13 1/4	1/2	3/8	10
10	1 1/2	10CHTEF3-*	7 3/8	8 7/8	3 1/2	2 1/8	3 3/4	9 1/2	1 3/4	2 7/8	1/4	14 3/4	1/2	3/8	12
	2	10CHTEF4-*	7 3/8	8 7/8	4 7/16	2 1/2	3 7/8	9 1/2	1 3/4	2 7/8	1/4	14 3/4	1/2	3/8	12
12	2	12CHTEF4-*	8 1/8	9 5/8	4 7/16	2 1/2	3 7/8	12 1/4	1 5/8	2 3/4	1/4	16 1/4	5/8	1/2	22
	2 7/16	12CHTEF5-*	8 1/8	9 5/8	5 5/16	2 9/16	4 7/16	12 1/4	1 5/8	2 3/4	1/4	16 1/4	5/8	1/2	22
	3	12CHTEF6-*	8 1/8	9 5/8	5 15/16	3 3/4	4 15/16	12 1/4	1 5/8	2 3/4	1/4	16 1/4	5/8	1/2	22
14	2 7/16	14CHTEF5-*	9 1/8	10 7/8	5 5/16	2 9/16	4 7/16	13 1/2	1 5/8	2 7/8	1/4	18 1/4	5/8	1/2	24
	3	14CHTEF6-*	9 1/8	10 7/8	5 15/16	3 3/8	4 15/16	13 1/2	1 5/8	2 7/8	1/4	18 1/4	5/8	1/2	24
16	3	16CHTEF6-*	10 5/8	12	6	3 7/16	5	14 7/8	2	3 1/4	5/16	21 1/4	5/8	5/8	44
18	3	18CHTEF6-*	12 1/8	13 3/8	6 1/16	3 1/2	5 1/16	16	2	3 1/4	3/8	24 1/4	5/8	5/8	56
	3 7/16	18CHTEF7-*	12 1/8	13 3/8	6 5/8	3 3/4	5 5/8	16	2	3 1/4	3/8	24 1/4	5/8	5/8	56
20	3	20CHTEF6-*	13 1/8	15	6 1/16	3 1/2	5 1/16	19 1/4	2 1/4	3 3/4	3/8	26 1/4	3/4	5/8	92
	3 7/16	20CHTEF7-*	13 1/8	15	6 5/8	3 3/4	5 5/8	19 1/4	2 1/4	3 3/4	3/8	26 1/4	3/4	5/8	92
24	3 7/16	24CHTEF7-*	15 1/8	18 1/8	6 5/8	3 3/4	5 5/8	20	2 1/2	4 1/8	3/8	30 1/4	3/4	5/8	134

-*BB-P Ball Bearing Plate Only
 -*RB-P Roller Bearing Plate Only

For Bolt Pattern see Page H-42

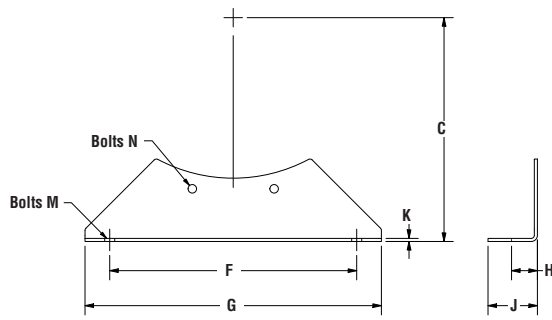

Flange Foot

Trough feet are used to support trough at trough connections.

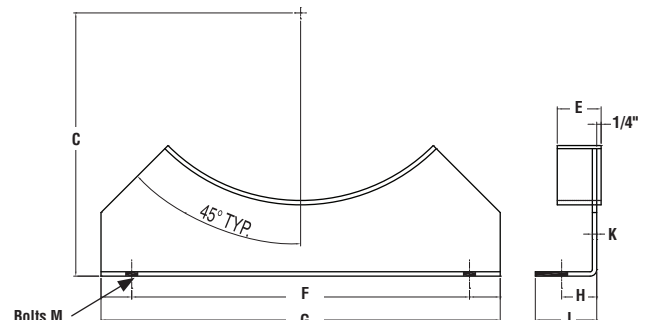

Saddle

Trough saddles are used to support trough where flange feet cannot be used at connections

Conveyor Diameter	Part Number			Weight		
	Saddle	Tubular	Flange Foot	Saddle	Tubular	Flange Foot
4	4TS	4CHTFF	4TFF	1.5	1	1.5
6	6TS	6CHTFF	6TFF	2.0	2	2.0
9	9TS	9CHTFF	9TFF	4.5	4.5	4.5
10	10TS	10CHTFF	10TFF	5.0	4.5	5.0
12	12TS	12CHTFF	12TFF	6.0	5	6.0
14	14TS	14CHTFF	14TFF	7.0	7	7.0
16	16TS	16CHTFF	16TFF	8.0	8	7.5
18	18TS	18CHTFF	18TFF	10.0	10	9.5
20	20TS	20CHTFF	20TFF	13.0	11	12.5
24	24TS	24CHTFF	24TFF	15.0	12	14.5

Conveyor Diameter	C	E	F	G	H	J	K	M*	N
4	4 5/8	1 7/16	5 3/4	7 3/8	1	1 5/8	3/16	3/8	3/8
6	5 5/8	1 7/16	8 1/8	10	1 1/4	2	3/16	3/8	3/8
9	7 7/8	1 3/4	9 3/8	12	1 1/2	2 5/8	3/16	1/2	3/8
10	8 7/8	1 3/4	9 1/2	12 3/8	1 3/4	2 7/8	3/16	1/2	3/8
12	9 5/8	1 3/4	12 1/4	15	1 5/8	2 3/4	1/4	5/8	1/2
14	10 7/8	2	13 1/2	16 1/2	1 5/8	2 7/8	1/4	5/8	1/2
16	12	2	14 7/8	18	2	3 1/4	1/4	5/8	5/8
18	13 3/8	2	16	19 1/8	2	3 1/4	1/4	5/8	5/8
20	15	2 1/2	19 1/4	22 3/4	2 1/4	3 3/4	1/4	3/4	5/8
24	18 1/8	2 1/2	20	24	2 1/2	4	1/4	3/4	5/8

* Holes for Bolt M Slotted

Trough End Flanges

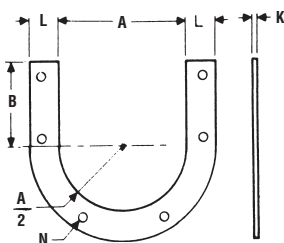

Size	Part Number	A		B	K	L	N	Weight	Red Rubber Gasket
		Trough Thickness							Part Number
		Thru 10 Ga.	3/16 & 1/4						
4	4TF*	5 1/4	5 3/8	3 3/8	1/4	1 1/4	3/8	.09	4TFG
6	6TF*	7 1/4	7 3/8	4 1/4	1/4	1 1/2	3/8	1.5	6TFG
9	9TF*	10 1/4	10 1/2	5 7/8	1/4	13/4	3/8	2.4	9TFG
10	10TF*	11 1/4	11 1/2	6 1/8	1/4	13/4	3/8	2.6	10TFG
12	12TF*	13 1/4	13 1/2	7 1/2	1/4	2	1/2	5.6	12TFG
14	14TF*	15 1/4	15 1/2	9	1/4	2	1/2	6.5	14TFG
16	16TF*	17 1/4	17 1/2	10 3/8	1/4	2	5/8	7.4	16TFG
18	18TF*	19 1/4	19 1/2	11 13/16	1/4	2 1/2	5/8	10.2	18TFG
20	20TF*	21 1/4	21 1/2	13 3/16	1/4	2 1/2	5/8	11.3	20TFG
24	24TF*	25 1/4	25 1/2	16 1/2	1/4	2 1/2	5/8	15.5	24TFG

*-10 used for troughs through 10 ga., -3 used for troughs 3/16 and 1/4 thick.

*** For White Rubber Gasket Add WN

End Bearing



KEEP THE HOUSING REPLACE THE INSERT.

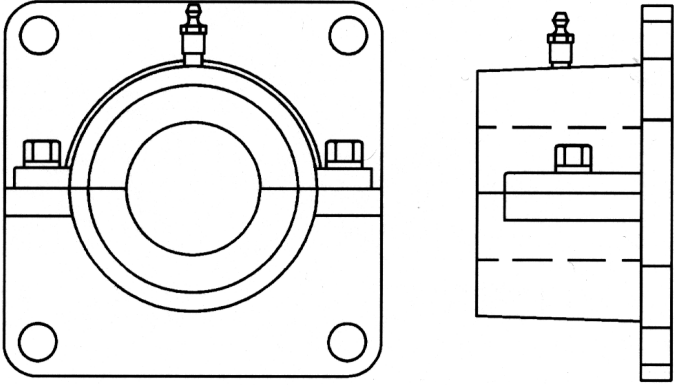

TEBH- Split Bearing Housings will help cut down on a plant's repair parts inventory, as well as the cost of the bearing. The rugged cast iron housing is not subject to wear, only the Style 220 Hanger bearing insert needs to be replaced.

The housings match CEMA standard ball bearing bolt pattern, so they can be used with most seals.

Split bearing housings are stocked in all *Martin* stocking facilities. Call your *Martin* distributor for more information.

TROUGH END BEARING HOUSINGS

Martin Split Bearing Housings utilize *Martin* Style 220 Hanger Bearings.

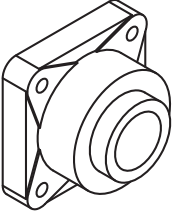
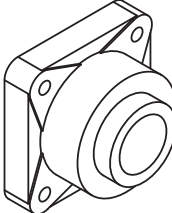
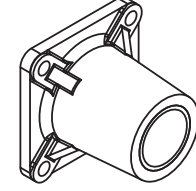
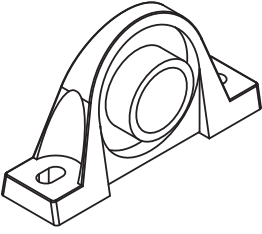
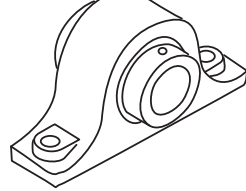
FLANGE UNITS	Mounted on trough end plate		Ball Bearing Flange Unit
			Roller Bearing Flange Unit
			Bronze Sleeve Bearing Flange Unit
PILLOW BLOCKS	Mounted on pedestal of outboard bearing trough end.		Ball Bearing Pillow Block
			Roller Bearing Pillow Block

Bronze Flange Unit

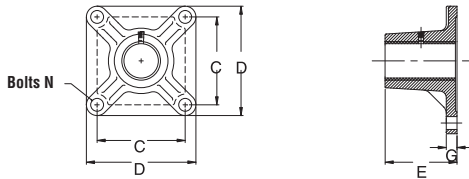

Bore	Part Number	C	D	E	G	N
1	TEB2BR	2 3/4	3 3/4	2	17/32	3/8
1 1/2	TEB3BR	4	5 1/8	3 1/4	9/16	1/2
2	TEB4BR	5 1/8	6 3/8	4 3/16	5/8	5/8
2 7/16	TEB5BR	5 5/8	6 7/8	4 15/16	13/16	5/8
3	TEB6BR	6	7 3/4	5 11/16	7/8	5/8
3 7/16	TEB7BR	6 3/4	8 7/16	6 1/4	1	13/16

Ball Bearing Flange Unit

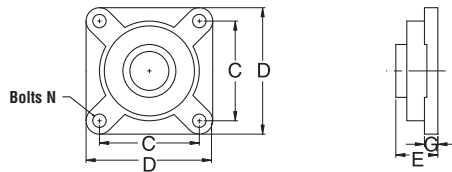

Bore	Part Number	C	D	E	G	N
1	TEB2BB	2 3/4	3 3/4	1 3/8	1/2	3/8
1 1/2	TEB3BB	4	5 1/8	1 7/8	9/16	1/2
2	TEB4BB	5 1/8	6 1/2	2 3/8	11/16	5/8
2 7/16	TEB5BB	5 5/8	7	2 5/16	11/16	5/8
3	TEB6BB	6	7 3/4	3 1/8	7/8	3/4
3 7/16	TEB7BB	6 3/4	8 7/16	3 3/8	1	3/4

Roller Bearing Flange Unit

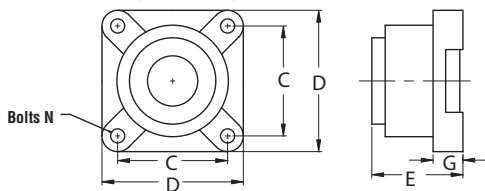

Bore	Part Number	C	D	E	G	N
1 1/2	TEB3R	4 1/8	5 3/8	3 1/2	1 3/16	1/2
2	TEB4R	4 3/8	5 5/8	3 5/8	1 3/16	1/2
2 7/16	TEB5R	5 3/8	6 7/8	4 3/16	1 1/2	5/8
3	TEB6R	6	7 3/4	4 11/16	1 5/8	3/4
3 7/16	TEB7R	7	9 1/4	5 1/4	1 7/8	3/4

Bronze Discharge Unit

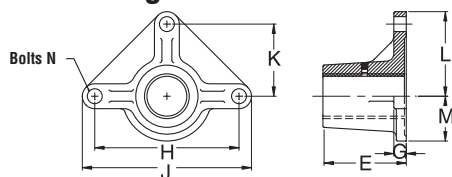

Bore	Part Number	E	G	H	J	K	L	M	N
1	TDB2BR	2	1/2	3 7/8	5 3/8	1 15/16	2 11/16	1	3/8
1 1/2	TDB3BR	3 1/4	9/16	5 5/8	7 1/4	2 13/16	3 5/8	1 1/4	1/2
2	TDB4BR	4 3/16	5/8	7 1/4	8	3 5/8	4	1 5/8	5/8
2 7/16	TDB5BR	4 15/16	11/16	8	9 7/8	4	4 15/16	1 7/8	5/8
3	TDB6BR	5 11/16	7/8	8 1/2	11	4 1/4	5 1/2	2 1/8	5/8
3 7/16	TDB7BR	6 1/4	1	9 1/2	12	4 3/4	6	2 1/2	3/4

Ball Bearing Discharge Unit

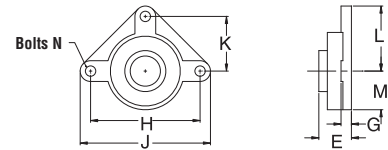

Bore	Part Number	E	G	H	J	K	L	M	N
1	TDB2BB	1 3/8	1/2	3 7/8	5 3/8	1 15/16	2 11/16	2	3/8
1 1/2	TDB3BB	2	9/16	5 5/8	7 1/4	2 13/16	3 5/8	2 1/2	1/2
2	TDB4BB	2 1/8	5/8	7 1/4	8	3 5/8	4	3	5/8
2 7/16	TDB5BB	2 1/2	11/16	8	9 7/8	4	4 15/16	3 1/2	5/8
3	TDB6BB	3 1/2	7/8	8 1/2	11	4 1/4	5 1/2	4	3/4
3 7/16	TDB7BB	4	1	9 1/2	12	4 3/4	6	4 1/2	3/4

Trough End Bearing Housing

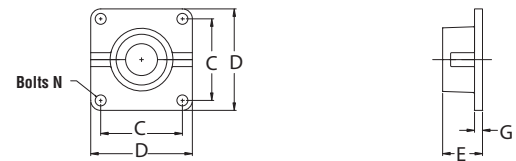

Bore	Part Number	C	D	E	G	N
1 1/2	TEBH3	4	5 1/4	2 1/2	1/2	1/2
2	TEBH4	5 1/8	6 3/8	2 1/2	1/2	5/8
2 7/16	TEBH5	5 5/8	6 7/8	3 9/16	9/16	5/8
3	TEBH6	6	7 3/4	3 5/8	5/8	3/4
3 7/16	TEBH7	7	9 1/4	4 3/4	3/4	3/4

Use #220 Type Hanger Bearings, See Page H-93.

Ball Bearing Pillow Block

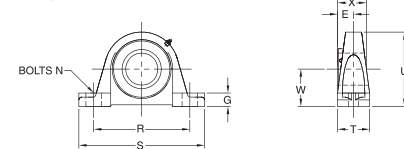

Bore	Part Number	E	G	N	R	S	T	U	W	X
1	TPB2BB	51/64	19/32	3/8	4 1/8	5 1/2	1 1/16	2 13/16	1 7/16	1 11/64
1 1/2	TPB3BB	1 11/64	7/8	1/2	5 1/2	7 1/4	1 7/8	4 1/8	2 1/8	1 21/64
2	TPB4BB	1 17/64	1	5/8	6 3/8	8 1/4	2 1/8	4 17/64	2 1/4	1 13/16
2 7/16	TPB5BB	1 15/16	1 1/16	5/8	7 3/8	9 5/8	2 3/8	5 15/32	2 3/4	1 57/64
3	TPB6BB	1 1/2	1 1/4	7/8	9	11 3/4	3	6 31/32	3 1/2	2 3/8
3 7/16	TPB7BB	1 9/16	1 11/32	7/8	11	14	3 3/8	7 7/8	4	2 23/64

Roller Bearing Pillow Block

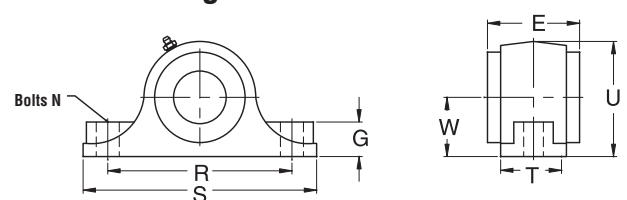

Bore	Part Number	E	G	N	R	S	T	U	W
1 1/2	TPB3R	3 3/8	1 1/4	1/2	6 1/4	7 7/8	2 3/8	4 1/4	2 1/8
2	TPB4R	3 1/2	1 3/8	5/8	7	8 7/8	2 1/2	4 1/2	2 1/4
2 7/16	TPB5R	4	1 5/8	5/8	8 1/2	10 1/2	2 7/8	5 1/2	2 3/4
3	TPB6R	4 1/2	1 7/8	3/4	9 1/2	12	3 1/8	6 1/4	3 1/8
3 7/16	TPB7R	5	2 1/4	7/8	11	14	3 5/8	7 1/2	3 3/4

Thrust Bearings

Martin

TYPE E THRUST BEARINGS

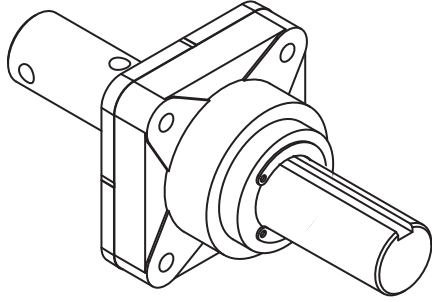

Most common and economical thrust unit when a screw conveyor type drive is not being used.

TYPE H THRUST BEARINGS

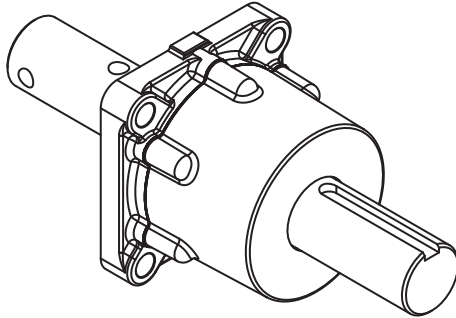

For heavy-duty thrust requirements.

BRONZE WASHER

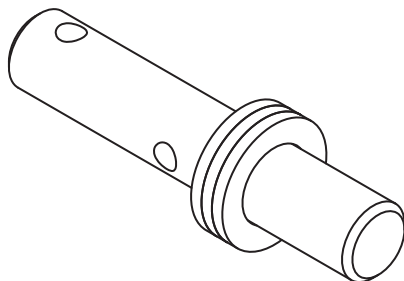

Light duty applications only.
Used inside the trough and when screw used in compression.

Type E Thrust Assembly

Type E roller thrust bearings are designed to carry thrust in both directions and carry radial load under normal conditions. This double roller bearing is furnished with a lip type seal plate and either drive or tail shaft whichever is applicable to conveyor design.

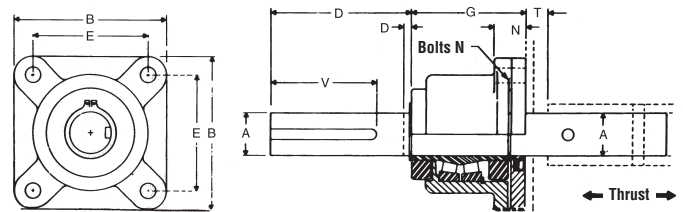

A	Part Number		B	D		E	G	H	N	T	V	Weight	
	Drive Shaft	End Shaft		Drive Shaft	End Shaft							Drive Shaft	End Shaft
1 1/2	CT3D	CT3E	5 3/8	4 3/4	3/4	4 1/8	4	1 11/16	1/2	1 1/4	4	22	20
2	CT4D	CT4E	5 5/8	5	3/4	4 3/8	4 1/8	1 11/16	1/2	1 1/4	4 1/2	32	29
2 7/16	CT5D	CT5E	6 7/8	5 1/2	3/4	5 3/8	4 11/16	2	5/8	1 13/16	5	50	44
3	CT6D	CT6E	7 3/4	6 1/2	3/4	6	5 3/16	2 1/8	3/4	1 7/8	6	73	60
3 7/16	CT7D	CT7E	9 1/4	7 1/2	3/4	7	6	2 5/8	3/4	2 3/8	7	111	88

Heavy-Duty RB End Thrust Bearings

Type E roller thrust bearings are designed to carry thrust in both directions and carry radial load under normal conditions. This double roller bearing is furnished with a lip type seal plate and either drive or tail shaft whichever is applicable to conveyor design.

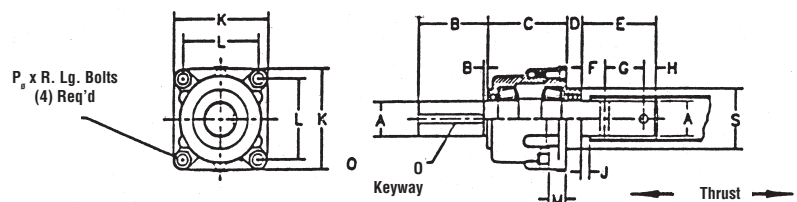

A	With Drive Shaft		With Tail Shaft		B		C	D	E	F	G	H	J	K	L	M	O	P	R	S
	Shaft Dia.	Part Number	Wt.	Part Number	Wt.	Drive Shaft														
1 1/2	CTH3D	60	CTH3E	52	4 1/2	1/4	6 3/4	1 1/8	4 7/8	1	3	7/8	1/8	7 1/4	5 3/4	1 3/16	3/8 x 4 1/4	3/4	2 1/2	4 3/4
2	CTH4D	65	CTH4E	56	4 1/2	1/4	6 3/4	1 1/8	4 7/8	1	3	7/8	1/8	7 1/4	5 3/4	1 3/16	1/2 x 4 1/4	3/4	2 1/2	4 3/4
2 7/16	CTH5D	80	CTH5E	66	5 9/16	5/16	6 1/4	1 1/4	5 7/16	1 1/2	3	15/16	9/16	8	6 1/4	1 1/2	5/8 x 5 1/4	3/4	3	5 1/2
3	CTH6D	145	CTH6E	119	6 1/8	1/4	8 1/4	1 1/2	5 3/8	1 3/8	3	1	3/8	10	8	1 3/4	3/4 x 5 3/4	1	3 1/2	6
3 7/16	CTH7D	170	CTH7E	140	7 1/8	3/8	8 1/4	1 1/2	7 5/8	2 3/8	4	1 1/4	7/8	10	8	1 3/4	7/8 x 6 3/4	1	3 1/2	6

Dimensions in inches and average weight in pounds.
Other shaft sizes available are 3 15/16", 4 7/16" & 4 15/16". Please consult factory.

Thrust Washers

Thrust washers are designed for use where light thrust loads prevail. Style A or B mounting may be used depending on direction of thrust. This unit consists of two steel washers separated by one bronze washer, and Style B is not recommended for use in conveyors handling abrasive materials.

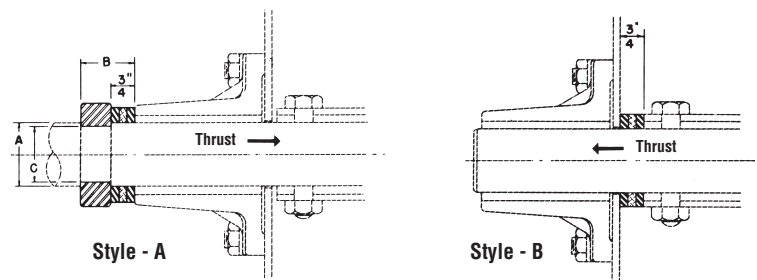

A	Washers & Collar Style A		Washer Set Style B		B	C
	Size Shaft	Part Number	Weight	Part Number		
1 1/2	CTCW3	2.4	CTW3	1	1 1/4	1 1/4
2	CTCW4	2.8	CTW4	1.25	1 7/16	1 3/4
2 7/16	CTCW5	3.9	CTW5	1.5	1 1/2	2 1/8
3	CTCW6	4.6	CTW6	2	1 1/2	2 3/4
3 7/16	CTCW7	6.1	CTW7	3	1 5/8	3 1/4

Shaft Seals

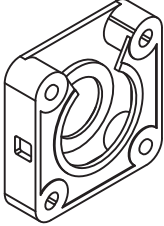
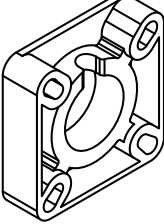
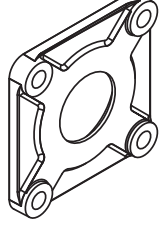
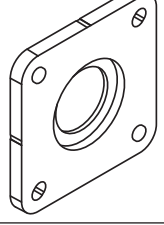
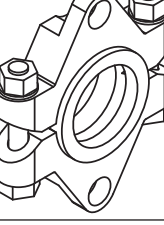
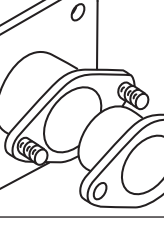
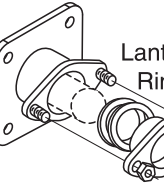

<p>WASTE PACK SEAL</p>		<p>Waste pack seals can be furnished with waste packing or in combination with lip seal. This type seal is normally installed between the trough end and bearing, but may be used separately on pedestal type trough ends. An opening is provided at top for repacking without removing seal from trough end. Can be used with flanged ball, roller or other standard 4-bolt bearings.</p>
<p><i>Martin</i> SUPER PACK SEAL</p>		<p><i>Martin</i> Super Pack Seal combines the heavy duty waste pack housing with the superior sealing characteristics of a Super Pack Seal. Seal may also be air or grease purged for difficult sealing applications.</p>
<p>PRODUCT DROP OUT SEAL</p>		<p>This flange type dust seal is designed for insertion between trough end and flanged ball bearing. The cast iron housing is open on all four sides for exit of material that might work past seal or lubricant from bearing.</p>
<p>PLATE SEAL</p>		<p>Plate seals are the most common and economical seal. It is normally furnished with a lip seal. This type seal is normally installed between the trough end and bearing, but may be used separately on pedestal type trough ends. Can be used with flanged ball, roller or other standard 4-bolt bearings.</p>
<p>SPLIT GLAND SEAL</p>		<p>Split gland compression type seals provide for easy replacement and adjustment of packing pressure on the shaft without removal of the conveyor. These seals can be installed inside or outside the end plates.</p>
<p>COMPRESSION TYPE PACKING GLAND SEAL</p>		<p>Flanged packing gland seals consist of an external housing and an internal gland which is forced into the housing to compress the packing. This is the most positive type shaft seal and may be used where minor pressure requirements are desired.</p>
<p>AIR-PURGED SEAL</p>	 <p>Lantern Ring</p>	<p>Air purge shaft seals are arranged for attaching to standard or special trough ends. A constant air pressure is maintained to prevent material from escaping from the trough along the shaft. The air purge seal is desirable for sealing highly abrasive materials. May be purged with grease or water.</p>

Compression Type Packing Gland Seal

Flanged gland seals consist of an external housing and an internal gland which is forced into the housing to compress the packing. This is the most positive type shaft seal and may be used where pressure requirements are desired.

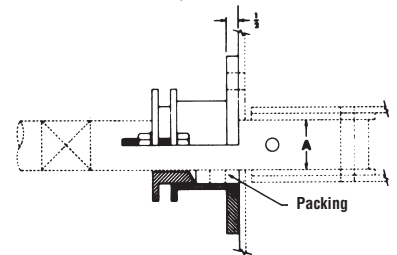
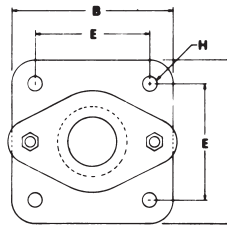

Shaft Diameter	Part Number	B	E	H Bolts	Weight
1 1/2	PGC3	5 1/4	4	1/2	14
2	PGC4	7 1/8	5 1/8	5/8	18
2 7/16	PGC5	7 5/8	5 5/8	5/8	21
3	PGC6	8 1/2	6	3/4	27
3 7/16	PGC7	9 1/4	6 3/4	3/4	30

*Braided rope graphite packing is standard. Other types available on request.

Split Gland Seal

Split gland compression type seals provide for easy replacement and adjustment of packing pressure on the shaft without removal of the conveyor. These seals are normally installed inside the end plates.

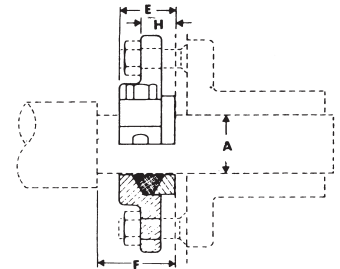
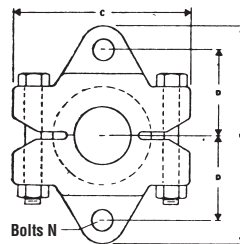

Shaft Diameter	Part Number	C	D	E	F	G	H	N	Weight
1 1/2	CSS3	4 3/4	2 3/16	1 7/16	2 1/2	5 7/8	7/8	1/2	5
2	CSS4	6 1/4	2 5/8	1 1/2	2 1/2	6 1/2	7/8	1/2	10
2 7/16	CSS5	6 7/8	3 1/16	1 5/8	3 1/4	7 5/8	1	5/8	15
3	CSS6	7 1/2	3 9/16	1 5/8	3 1/4	8 5/8	1	5/8	22
3 7/16	CSS7	8 3/4	4 1/8	2 1/8	3 3/4	10 1/4	1 1/4	3/4	30

Flanged Product Drop-Out Seal

This flange type dust seal is designed for insertion between trough end and flanged bearing. The cast iron housing is open on all four sides for exit of material that might work past seal or lubricant from bearing.

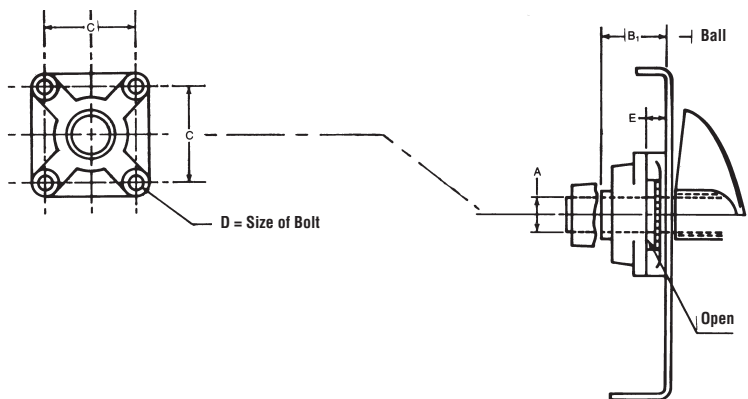

Shaft Diameter	Part Number	Weight	B ₁	C	E	D
1	CSFP2	1.75	2 1/8	2 3/4	11/16	3/8
1 1/2	CSFP3	3.4	2 57/64	4	7/8	1/2
2	CSFP4	5.3	3 3/16	5 1/8	7/8	5/8
2 7/16	CSFP5	5.8	3 9/16	5 5/8	7/8	5/8
3	CSFP6	7.2	4 3/8	6	7/8	3/4
3 7/16	CSFP7	10.3	4 31/32	6 3/4	1	3/4

Shaft Seals



Martin Super Pack Seal

Martin Super Pack Seal combines the heavy duty waste pack housing with the superior sealing characteristics of a Super Pack Seal. Seal may also be air or grease purged for difficult sealing applications.

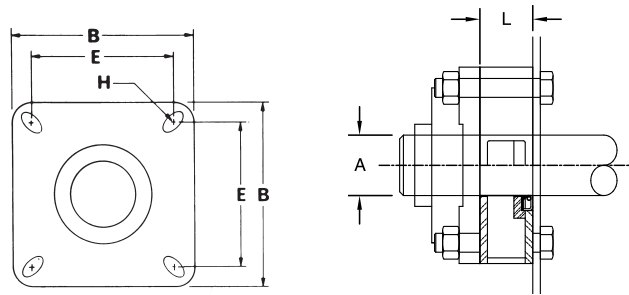

With Super Pack Seal

A Shaft Diameter	Part Number	B	L	E		H Bolts		Weight
				(-B)	(-R)	(-B)	(-R)	
1 1/2	MSP3	5 3/8	1 3/4	4	4 1/8	1/2	1/2	6
2	MSP4	6 1/2	1 3/4	5 1/8	4 3/8	5/8	1/2	8
2 7/16	MSP5	7 3/8	1 3/4	5 5/8	5 3/8	5/8	5/8	10
3	MSP6	7 3/4	1 3/4	6	6	3/4	3/4	13
3 7/16	MSP7	9 1/4	2 1/4	6 3/4	7	3/4	3/4	16

Waste Pack Seal

Waste pack seals are furnished with waste packing in combination with lip seal. This type seal is normally installed between the trough end and bearing, but may be used separately on pedestal type trough ends. An opening is provided at top for repacking without removing seal from trough end.

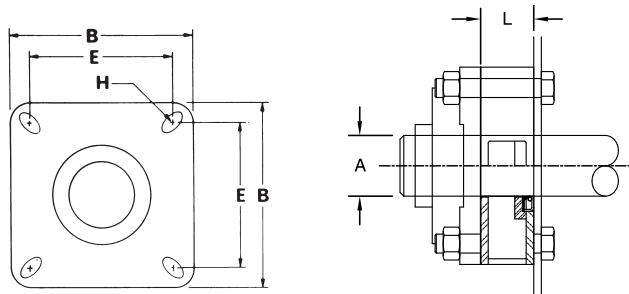

With Lip Seal

A Shaft Diameter	Part Number	B	L	E		H Bolts		Weight
				(-B)	(-R)	(-B)	(-R)	
1 1/2	CSW3	5 3/8	1 3/4	4	4 1/8	1/2	1/2	6
2	CSW4	6 1/2	1 3/4	5 1/8	4 3/8	5/8	1/2	8
2 7/16	CSW5	7 3/8	1 3/4	5 5/8	5 3/8	5/8	5/8	10
3	CSW6	7 3/4	1 3/4	6	6	3/4	3/4	13
3 7/16	CSW7	9 1/4	2 1/4	6 3/4	7	3/4	3/4	16

Plate Seal

Plate seals are the most common and economical seal. They are furnished with a lip seal. This type seal is normally installed between the trough end and bearing, but may be used separately on pedestal type trough ends. Slotted mounting holes allow use with both ball and roller flanged bearings.

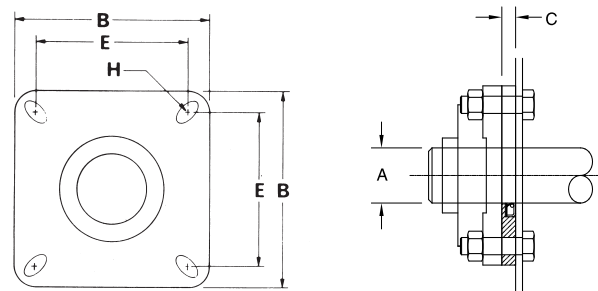

A Shaft Diameter	Part Number	B	C	E		H Bolts		Weight
				(-B)	(-R)	(-B)	(-R)	
1 1/2	CSP3	5 3/8	1/2	4	4 1/8	1/2	1/2	2
2	CSP4	6 1/2	1/2	5 1/8	4 3/8	5/8	1/2	3
2 7/16	CSP5	7 3/8	1/2	5 5/8	5 3/8	5/8	5/8	4
3	CSP6	7 3/4	1/2	6	6	3/4	3/4	5
3 7/16	CSP7	9 1/4	3/4	6 3/4	7	3/4	3/4	8

STANDARD PITCH, SINGLE FLIGHT

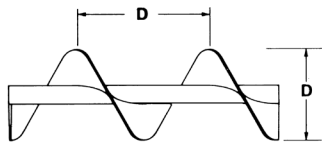

Conveyor screws with pitch equal to screw diameter are considered standard. They are suitable for a whole range of materials in most conventional applications.

TAPERED, STANDARD PITCH, SINGLE FLIGHT

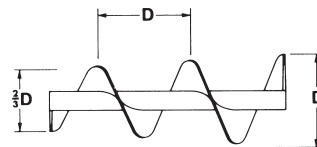

Price on Application

Screw flights increase from 2/3 to full diameter. Used in screw feeders to provide uniform withdrawal of lumpy materials. Generally equivalent to and more economical than variable pitch.

SHORT PITCH, SINGLE FLIGHT

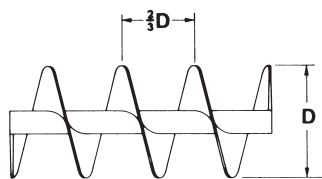

Flight pitch is reduced to 2/3 diameter. Recommended for inclined or vertical applications. Used in screw feeders. Shorter pitch reduces flushing of materials which fluidize.

SINGLE CUT-FLIGHT, STANDARD PITCH

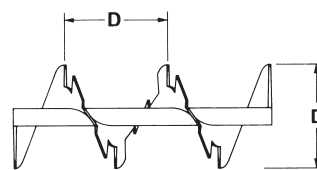

Screws are notched at regular intervals at outer edge. Affords mixing action and agitation of material in transit. Useful for moving materials which tend to pack.

HALF PITCH, SINGLE FLIGHT

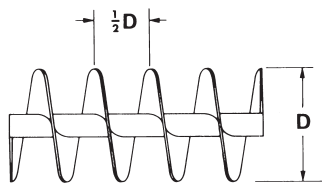

Similar to short pitch except pitch is reduced to 1/2 standard pitch. Useful for inclined applications, for screw feeders and for handling extremely fluid materials.

CUT & FOLDED FLIGHT, STANDARD PITCH

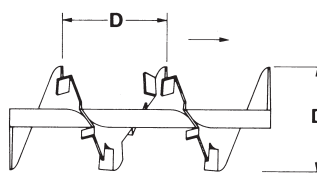

Folded flight segments lift and spill the material. Partially retarded flow provides thorough mixing action. Excellent for heating, cooling or aerating light substances.

END DISC ON CONVEYOR SCREW

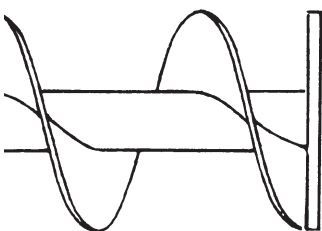

Price on Application

An end disc is the same diameter as the screw and is welded flush with the end of the pipe shaft at its discharge end and, of course, rotates with the screw. The end disc helps to keep discharging material away from the trough end seal.

SINGLE FLIGHT RIBBON

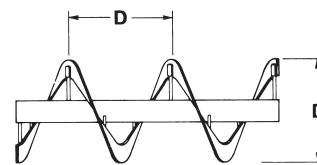

Excellent for conveying sticky or viscous materials. Open space between flighting and pipe eliminate collection and build-up of material.

VARIABLE PITCH, SINGLE FLIGHT

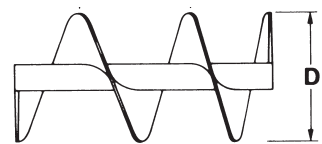

Price on Application

Flights have increasing pitch and are used in screw feeders to provide uniform withdrawal of fine, free flowing materials over the full length of the inlet opening.

STANDARD PITCH WITH PADDLES

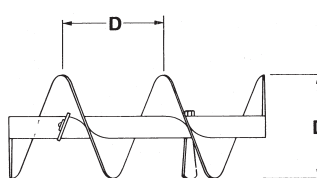

Adjustable paddles positioned between screw flights opposed flow to provide gentle but thorough mixing action.

DOUBLE FLIGHT, STANDARD PITCH

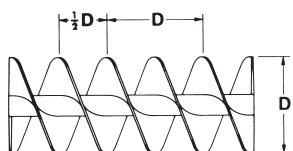

Double flight, standard pitch screws provide smooth regular material flow and uniform movement of certain types or materials.

PADDLE

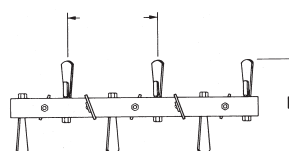

Adjustable paddles provide complete mixing action, and controlled material flow.

Conveyor Screws



Helicoid flights are formed in a special rolling machine by forming a steel strip into a continuous one-piece helix of the desired diameter, pitch and thickness to fit conveyor screw pipes. The helicoid flight is tapered in cross section, with the thickness at the inner edge approximately twice the thickness of the outer edge.

Sectional flights are individual flights or turns blanked from steel plates and formed into a spiral or helix of the desired diameter and pitch to fit conveyor screw pipes. The flights are butt welded together to form a continuous conveyor screw. Modifications can be furnished, such as, fabrication from various metals, different flight thicknesses, other diameters and pitches. The butt weld flight is the same thickness in the full cross section.

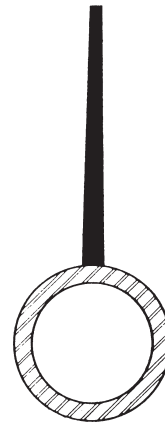

Helicoid Flight

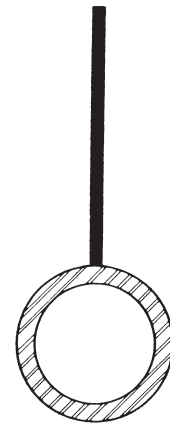

Sectional Flight

Key to Conveyor Size Designation

The letter “H” indicates screw conveyor with helicoid flighting. The figures to the left of the letters indicate the nominal outside diameter of the conveyor in inches. The first figure following the letters is twice the diameter of the couplings in inches. The last two figures indicate the nominal thickness of flighting at the outer edge in 1/64". Thus conveyor 12H408 indicates 12" diameter helicoid conveyor for 2" couplings with flighting 8/64" or 1/8" thickness at outer edge. Hand of conveyor is indicated by “R” or “L” following the designation.

Comparison Table • helicoid flight and sectional flight conveyor screws

Screw Diameter	Helicoid Flight						Sectional Flight			
	Conveyor Screw Size Designation ▽	Former Designation	Coupling Diameter	Nominal Inside Diameter of Pipe	Thickness of Flight		Conveyor Screw Size Designation ▽	Coupling Diameter	Nominal Inside Diameter of Pipe	Thickness of Flight
					Inner Edge	Outer Edge				
4	4H206	4 X	1	1 3/8	3/16	3/32	—	—	—	—
6	6H304	6 Standard	1 1/2	2	1/8	1/16	—	—	—	—
	6H308	6 X	1 1/2	2	1/4	1/8	6S309	1 1/2	2	10 ga.
	6H312	6 XX	1 1/2	2	3/8	3/16	6S312	1 1/2	2	3/16 in.
	9H306	9 Standard	1 1/2	2	3/16	3/32	9S307	1 1/2	2	12 ga.
9	9H406	9 Special	2	2 1/2	3/16	3/32	9S407	2	2 1/2	12 ga.
	9H312	9 X	1 1/2	2	3/8	3/16	9S312	1 1/2	2	3/16 in.
	9H412	9 XX	2	2 1/2	3/8	3/16	9S412	2	2 1/2	3/16 in.
	9H414	—	2	2 1/2	7/16	7/32	9S416	2	2 1/2	1/4 in.
	10H306	10 Standard	1 1/2	2	3/16	3/32	10S309	1 1/2	2	10 ga.
10	10H412	10 XX	2	2 1/2	3/8	3/16	10S412	2	2 1/2	3/16 in.
	12H408	12 Standard	2	2 1/2	1/4	1/8	12S409	2	2 1/2	10 ga.
12	12H508	12 Special	2 7/16	3	1/4	1/8	12S509	2 7/16	3	10 ga.
	12H412	12 X	2	2 1/2	3/8	3/16	12S412	2	2 1/2	3/16 in.
	12H512	12 XX	2 7/16	3	3/8	3/16	12S512	2 7/16	3	3/16 in.
	12H614	—	3	3 1/2	7/16	7/32	12S616	3	3 1/2	1/4 in.
	14H508	14 Standard	2 7/16	3	1/4	1/8	14S509	2 7/16	3	10 ga.
14	14H614	14 XX	3	3 1/2	7/16	7/32	14S616	3	3 1/2	1/4 in.
	16H610	16 Standard	3	3 1/2	5/16	5/32	16S609	3	3 1/2	10 ga.
16	16H614	—	3	4	7/16	7/32	16S616	3	3 1/2	1/4 in.
	18H610	—	3	3 1/2	5/16	5/32	18S609	3	3 1/2	10 ga.

▽ Size designation: Examples: 12H412 and 12S412.
 12 = screw diameter in inches
 H = helicoid flight
 S = sectional flight
 4 = 2 times 2" coupling diameter
 12 = thickness of flight at periphery in increments of 1/64"

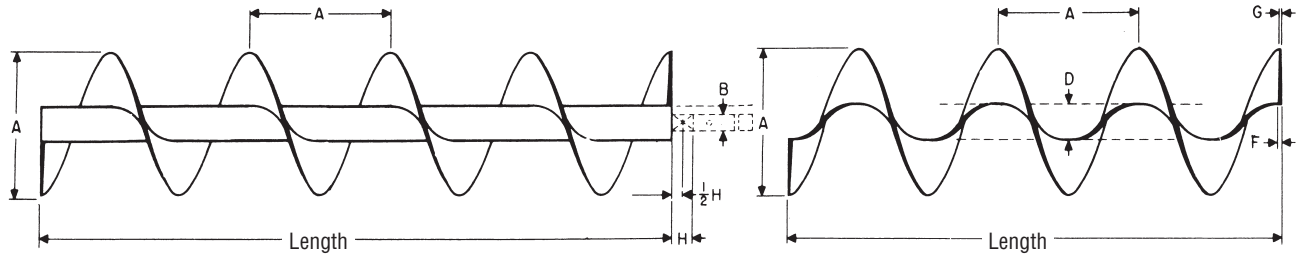

Helicoid Conveyor Screw

Flighting

Screw Diameter	Coupling Diameter	Size Part No. Conveyor Mounted	Size Part No. Flighting Only	D Pipe Size		Flight Thickness		H Coupling Bearing Length	Standard Length Feet – Inches	Average Weight			
				Nominal Inside	Outside	F Inside	G Outside			Complete Screw		Flighting Only	
										Standard Length	Per Foot	Standard Length	Per Foot
4	1	4H206-*	4HF206-*	1 3/8	1 5/8	3/16	3/32	1 1/2	9 – 10 1/2	40	4	16	1.3
6	1 1/2	6H304-*	6HF304-*	2	2 3/8	1/8	1/16	2	9 – 10	52	5	14	1.4
	1 1/2	6H308-*	6HF308-*	2	2 3/8	1/4	1/8	2	9 – 10	62	6	28	2.8
	1 1/2	6H312-*	6HF312-*	2	2 3/8	3/8	3/16	2	9 – 10	72	7	42	4.3
9	1 1/2	9H306-*	9HF306-*	2	2 3/8	3/16	3/32	2	9 – 10	70	7	31	3.2
	1 1/2	9H312-*	9HF312-*	2	2 3/8	3/8	3/16	2	9 – 10	101	10	65	6.1
	2	9H406-*	9HF406-*	2 1/2	2 7/8	3/16	3/32	2	9 – 10	91	9	30	3.0
	2	9H412-*	9HF412-*	2 1/2	2 7/8	3/8	3/16	2	9 – 10	121	12	60	6.6
	2	9H414-*	9HF414-*	2 1/2	2 7/8	7/16	7/32	2	9 – 10	131	13	70	6.3
10	1 1/2	10H306-*	10HF306-*	2	2 3/8	3/16	3/32	2	9 – 10	81	8	48	4.9
	2	10H412-*	10HF412-*	2 1/2	2 7/8	3/8	3/16	2	9 – 10	130	13	76	7.7
12	2	12H408-*	12HF408-*	2 1/2	2 7/8	1/4	1/8	2	11 – 10	140	12	67	5.7
	2	12H412-*	12HF412-*	2 1/2	2 7/8	3/8	3/16	2	11 – 10	180	15	102	8.6
	2 7/16	12H508-*	12HF508-*	3	3 1/2	1/4	1/8	3	11 – 9	168	14	64	5.4
	2 7/16	12H512-*	12HF512-*	3	3 1/2	3/8	3/16	3	11 – 9	198	17	96	8.2
14	3	12H614-*	12HF614-*	3 1/2	4	7/16	7/32	3	11 – 9	220	18	112	9.3
	2 7/16	14H508-*	14HF508-*	3	3 1/2	1/4	1/8	3	11 – 9	170	14	84	7.1
	3	14H614-*	14HF614-*	3 1/2	4	7/16	7/32	3	11 – 9	254	22	132	11.2
16	3	16H610-*	16HF610-*	3 1/2	4	5/16	5/32	3	11 – 9	228	19	120	10.0
	∇	3	16H614-*	16HF614-*	4	4 1/2	7/16	7/32	3	11 – 9	285	24	154
18 ∇	3	18H610-*	18HF610-*	3 1/2	4	5/16	5/32	3	11 – 9	282	24	167	13.9

∇ Offered only in full pitch helicoid flighting.

-* R For Right Hand

-* L For Left Hand

Conveyor Screws (Sectional)

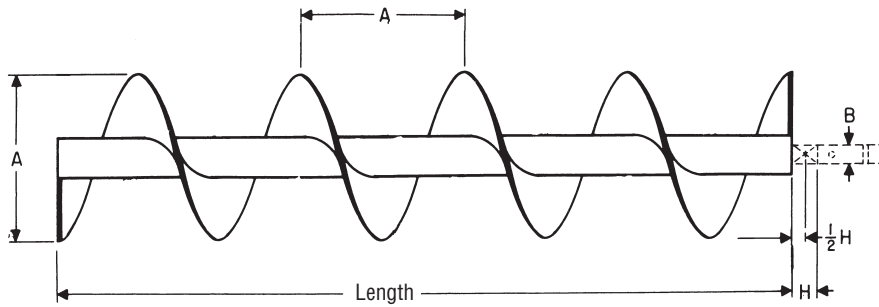

Sectional Conveyor Screw

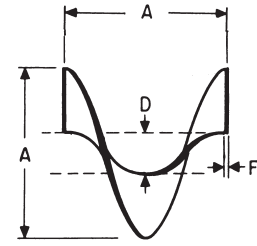

Flight

Screw Diameter	Coupling Diameter	Size Part No. Conveyor Mounted	Size Part No. Flighting Only	Pipe Size		F Flight Thickness	H Coupling Bearing Length	Standard Length Feet-Inches	Average Weight			Approx. Flight Per Foot
				Nominal Inside	D Outside				Standard Length	Per Foot	Flight Each	
6	1 1/2	6S312-*	6SF312-*	2	2 3/8	3/16	2	9 - 10	75	7.5	1.7	2.0
	1 1/2	6S316-*	6SF316-*	2	2 3/8	1/4	2	9 - 10	90	8.0	2.2	2.0
9	1 1/2	9S312-*	9SF312-*	2	2 3/8	3/16	2	9 - 10	95	9.5	4.3	1.33
	1 1/2	9S316-*	9SF316-*	2	2 3/8	1/4	2	9 - 10	130	13.0	5.5	1.33
	1 1/2	9S324-*	9SF324-*	2	2 3/8	3/8	2	9 - 10	160	16.0	7.9	1.33
	2	9S412-*	9SF412-*	2 1/2	2 7/8	3/16	2	9 - 10	115	11.5	4.3	1.33
	2	9S416-*	9SF416-*	2 1/2	2 7/8	1/4	2	9 - 10	130	13.0	5.5	1.33
10	2	9S424-*	9SF424-*	2 1/2	2 7/8	3/8	2	9 - 10	160	16.0	7.9	1.33
	1 1/2	10S312-*	10SF312-*	2	2 3/8	3/16	2	9 - 10	120	12.0	5.0	1.2
	1 1/2	10S316-*	10SF316-*	2	2 3/8	1/4	2	9 - 10	135	13.5	6.7	1.2
	1 1/2	10S324-*	10SF324-*	2	2 3/8	3/8	2	9 - 10	165	16.5	8.7	1.2
	2	10S412-*	10SF412-*	2 1/2	2 7/8	3/16	2	9 - 10	120	12.0	5.0	1.2
	2	10S416-*	10SF416-*	2 1/2	2 7/8	1/4	2	9 - 10	135	13.5	6.7	1.2
12	2	10S424-*	10SF424-*	2 1/2	2 7/8	3/8	2	9 - 10	165	16.5	8.7	1.2
	2	12S412-*	12SF412-*	2 1/2	2 7/8	3/16	2	11 - 10	156	13.0	7.2	1.0
	2	12S416-*	12SF416-*	2 1/2	2 7/8	1/4	2	11 - 10	204	17.0	9.7	1.0
	2	12S424-*	12SF424-*	2 1/2	2 7/8	3/8	2	11 - 10	268	22.3	12.7	1.0
	2 7/16	12S509-*	12SF509-*	3	3 1/2	10 Ga.	3	11 - 9	160	14.0	5.7	1.0
	2 7/16	12S512-*	12SF512-*	3	3 1/2	3/16	3	11 - 9	178	14.8	7.2	1.0
	2 7/16	12S516-*	12SF516-*	3	3 1/2	1/4	3	11 - 9	210	17.5	9.7	1.0
	2 7/16	12S524-*	12SF524-*	3	3 1/2	3/8	3	11 - 9	274	22.5	12.7	1.0
	3	12S612-*	12SF612-*	3 1/2	4	3/16	3	11 - 9	198	16.5	7.2	1.0
3	12S616-*	12SF616-*	3 1/2	4	1/4	3	11 - 9	216	18.0	9.7	1.0	
3	12S624-*	12SF624-*	3 1/2	4	3/8	3	11 - 9	280	24.0	12.7	1.0	

-* R For Right Hand
-* L For Left Hand

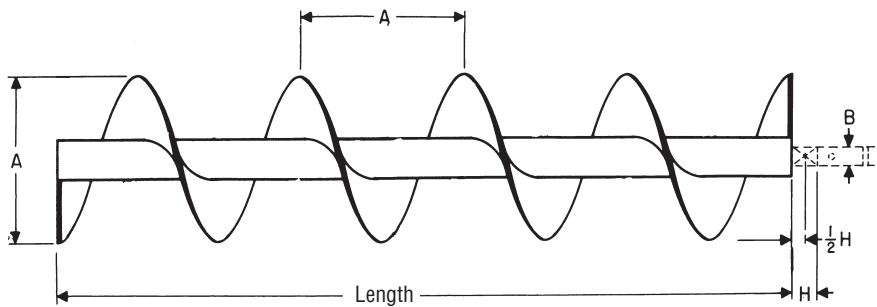

Sectional Conveyor Screw

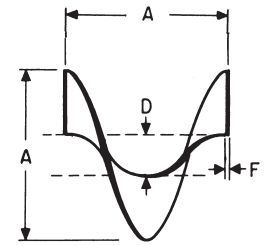

Flight

Screw Diameter	Coupling Diameter	Size Part No. Conveyor Mounted	Size Part No. Flighting Only	Pipe Size		F Flight Thickness	H Coupling Bearing Length	Standard Length Feet-Inches	Average Weight			Approx. Flight Per Foot
				Nominal Inside	D Outside				Standard Length	Per Foot	Flight Each	
14	2 7/16	14S512-*	14SF512-*	3	3 1/2	3/16	3	11 - 9	214	18.0	9.9	.86
	2 7/16	14S516-*	14SF516-*	3	3 1/2	1/4	3	11 - 9	240	20.0	13.2	.86
	2 7/16	14S524-*	14SF524-*	3	3 1/2	3/8	3	11 - 9	330	27.5	19.8	.86
	3	14S612-*	14SF612-*	3 1/2	4	3/16	3	11 - 9	222	19.0	9.9	.86
	3	14S616-*	14SF616-*	3 1/2	4	1/4	3	11 - 9	246	21.0	13.2	.86
	3	14S624-*	14SF624-*	3 1/2	4	3/8	3	11 - 9	342	29.0	19.8	.86
16	3	16S612-*	16SF612-*	3 1/2	4	3/16	3	11 - 9	234	20.0	14.0	.75
	3	16S616-*	16SF616-*	3 1/2	4	1/4	3	11 - 9	282	24.0	18.0	.75
	3	16S624-*	16SF624-*	3 1/2	4	3/8	3	11 - 9	365	31.0	25.5	.75
	3	16S632-*	16SF632-*	3 1/2	4	1/2	3	11 - 9	402	33.5	36.0	.75
18	3	18S612-*	18SF612-*	3 1/2	4	3/16	3	11 - 9	246	21.0	18.0	.67
	3	18S616-*	18SF616-*	3 1/2	4	1/4	3	11 - 9	294	25.0	24.0	.67
	3	18S624-*	18SF624-*	3 1/2	4	3/8	3	11 - 9	425	36.0	34.5	.67
	3	18S632-*	18SF632-*	3 1/2	4	1/2	3	11 - 9	530	44.0	46.0	.67
	3 7/16	18S712-*	18SF712-*	4	4 1/2	3/16	4	11 - 8	293	24.4	18.0	.67
	3 7/16	18S716-*	18SF716-*	4	4 1/2	1/4	4	11 - 8	345	28.8	24.0	.67
	3 7/16	18S724-*	18SF724-*	4	4 1/2	3/8	4	11 - 8	470	39.2	34.5	.67
	3 7/16	18S732-*	18SF732-*	4	4 1/2	1/2	4	11 - 8	570	47.5	46.0	.67
20	3	20S612-*	20SF612-*	3 1/2	4	3/16	3	11 - 9	300	26.0	20.0	.60
	3	20S616-*	20SF616-*	3 1/2	4	1/4	3	11 - 9	360	31.0	28.0	.60
	3	20S624-*	20SF624-*	3 1/2	4	3/8	3	11 - 9	410	33.4	40.0	.60
	3	20S632-*	20SF632-*	3 1/2	4	1/2	3	11 - 9	506	42.2	56.0	.60
	3 7/16	20S712-*	20SF712-*	4	4 1/2	3/16	4	11 - 8	310	27.0	20.0	.60
	3 7/16	20S716-*	20SF716-*	4	4 1/2	1/4	4	11 - 8	370	32.0	28.0	.60
24	3 7/16	24S724-*	24SF724-*	4	4 1/2	3/8	4	11 - 8	424	36.0		

-* R For Right Hand
-* L For Left Hand

Conveyor Screws (Ribbon)



Ribbon flight conveyor screws consist of sectional flights, butt-welded together to form a continuous helix. Flights are secured to the pipe by supporting legs. Both ends of the pipe are prepared with internal collars and drilling to accept couplings, drive shafts, and end shafts. They are used to convey sticky, gummy, or viscous substances, or where the material tends to adhere to flighting and pipe.

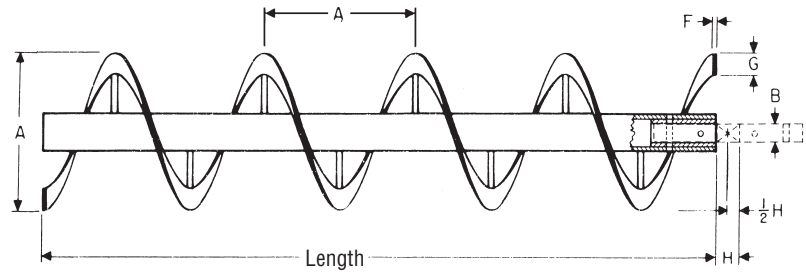

Ribbon Conveyor Screw

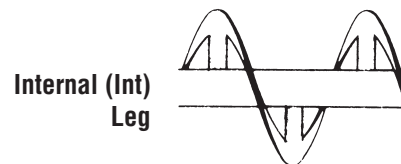
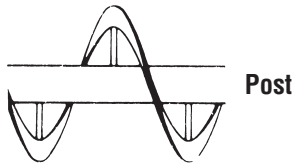

A Screw Diameter	B Coupling Diameter	Size Part No. Conveyor Mounted	Pipe Size		Flight Size		H Coupling Bearing Length	Standard Length Feet-Inches	Weight Complete Screw	
			Inside	Outside	F Thickness	G Width			Standard Length	Per Foot
6	1 1/2	6R312-*	2	2 3/8	3/16	1	2	9 - 10	65	6.5
9	1 1/2	9R316-*	2	2 3/8	1/4	1 1/2	2	9 - 10	100	10
10	1 1/2	10R316-*	2	2 3/8	1/4	1 1/2	2	9 - 10	110	11
12	2	12R416-*	2 1/2	2 7/8	1/4	2	2	11 - 10	180	15
	2	12R424-*	2 1/2	2 7/8	3/8	2 1/2	2	11 - 10	216	19
	2 7/16	12R524-*	3	3 1/2	3/8	2 1/2	3	11 - 9	240	21
14	2 7/16	14R516-*	3	3 1/2	1/4	2 1/2	3	11 - 9	228	19
	2 7/16	14R524-*	3	3 1/2	3/8	2 1/2	3	11 - 9	264	22
	3	14R624-*	3 1/2	4	3/8	2 1/2	3	11 - 9	288	25
16	3	16R616-*	3 1/2	4	1/4	2 1/2	3	11 - 9	276	24
	3	16R624-*	3 1/2	4	3/8	2 1/2	3	11 - 9	324	28
18	3	18R624-*	3 1/2	4	3/8	3	3	11 - 9	384	33
20	3 7/16	20R724-*	4	4 1/2	3/8	3	4	11 - 8	408	35
24	3 7/16	24R724-*	4	4 1/2	3/8	3	4	11 - 8	424	36

-* R For Right Hand
-* L For Left Hand

Quick Detachable (QD) Helicoid Conveyor

QD — Quick Detachable conveyor screws are designed for convenient removal from the conveyor assembly. Each section of screw has a QD cap at one end of the pipe. By removing this cap, a conveyor screw section can quickly and easily be removed and returned to the conveyor assembly without disturbing the other screw sections. Quick Detachable conveyor can be furnished both in helicoid and butt-weld construction.

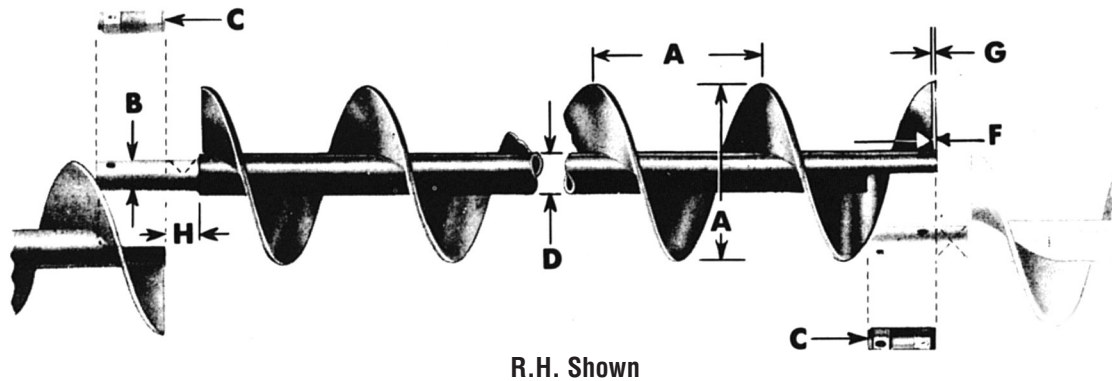

A Nominal Screw Diameter	Size Part No. Conveyor Mounted	B Coupling Diameter	Standard Length Feet-Inches End to End of Pipe	C Cap Part Number	D Pipe Size		Flight Thickness Ft.-In.		H Coupling Bearing Length	Average Weight	
					Inside	Outside	F Inside	G Outside		Standard Length	Per Foot
6	6HQ304-*	1 1/2	9-10	3QDC2	2	2 3/8	1/8	1/16	2	52	5
	6HQ308-*						1/4	1/8		62	6
	6HQ312-*						3/8	3/16		72	7
9	9HQ306-*	1 1/2	9-10	3QDC2	2	2 3/8	3/16	3/32	2	70	7
	9HQ312-*						3/8	3/16		101	10
	9HQ406-*	2	9-10	4QDC25	2 1/2	2 7/8	3/16	3/32	2	91	9
	9HQ412-*						3/8	3/16		121	12
	9HQ414-*						7/16	7/32		131	13
10	10HQ306-*	1 1/2	9-10	3QDC2	2	2 3/8	3/16	3/32	2	81	8
	10HQ412-*	2	9-10	4QDC25	2 1/2	2 7/8	3/8	3/16	2	130	13
12	12HQ408-*	2	11-10	4QDC25	2 1/2	2 7/8	1/4	1/8	2	140	12
	12HQ412-*						3/8	3/16		180	15
	12HQ508-*	2 7/16	11-9	5QDC3	3	3 1/2	1/4	1/8	3	168	14
	12HQ512-*						3/8	3/16		198	17
	12HQ614-*						3	7/16		7/32	3
14	14HQ508-*	2 7/16	11-9	5QDC3	3	3 1/2	1/4	1/8	3	170	14
	14HQ614-*	3	11-9	6QDC35	3 1/2	4	7/16	7/32	3	254	22
	16HQ610-*						5/16	5/32		228	19
16	16HQ614-*	3	11-9	6QDC4	4	4 1/2	7/16	7/32	3	285	23.8
	18HQ610-*	3	11-9	6QDC4	3 1/2	4	5/16	5/32	3	282	13.9

-* R For Right Hand
-* L For Left Hand

Conveyor Screws



Quick Detachable (QD) Sectional Spiral Conveyors

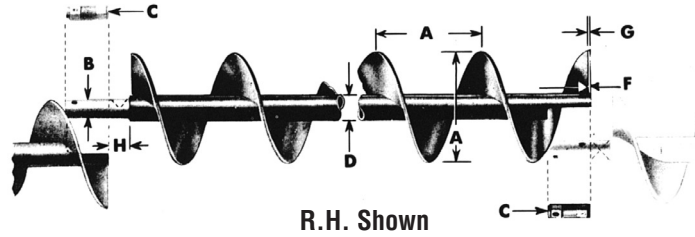

A Nominal Screw Diameter	Size Part No. Conveyor Mounted	B Coupling Diameter	Standard Length Feet-Inches End to End of Pipe	C Cap Part Number	D Pipe Size		F Flight Thickness	H Coupling Bearing Length	Average Weight			
					Inside	Outside			Standard Length	Per Foot		
6	6SQ307-*	1 1/2	9-10	3QDC2	2	2 3/8	12	2	62	6.2		
	6SQ309-*						10				65	6.5
	6SQ312-*						3/16				75	7.5
	6SQ316-*						1/4				90	8.0
9	9SQ307-*	1 1/2	9-10	3QDC2	2	2 3/8	12	2	73	7.3		
	9SQ309-*						10		80	8.0		
	9SQ312-*						3/16		95	9.5		
	9SQ316-*						1/4		120	13		
	9SQ407-*	2	9-10	4QDC25	2 1/2	2 7/8	12	2	90	9		
	9SQ409-*						10		100	10		
	9SQ412-*						3/16		115	11.5		
	9SQ416-*						1/4		130	13.0		
9SQ424-*	3/8	160	16									
10	10SQ309-*	1 1/2	9-10	3QDC2	2	2 3/8	10	2	85	8.5		
	10SQ412-*	2	9-10	4QDC25	2 1/2	2 7/8	3/16	2	120	12.0		
	10SQ416-*						1/4		135	13.5		
12	12SQ409-*	2	11-10	4QDC25	2 1/2	2 7/8	10	2	140	12.0		
	12SQ412-*						3/16		156	13.0		
	12SQ416-*						1/4		204	17		
	12SQ509-*	2 7/16	11-9	5QDC3	3	3 1/2	10	3	160	14		
	12SQ512-*						3/16		178	15		
	12SQ612-*						3/16		191	16.5		
	12SQ616-*						1/4		216	18.0		
12SQ624-*	3	11-9	6QDC35	3 1/2	4	3/8	3	280	24			
14	14SQ509-*	2 7/16	11-9	5QDC3	3	3 1/2	10	3	185	16		
	14SQ512-*						3/16		214	18		
	14SQ612-*	3	11-9	6QDC35	3 1/2	4	3/16	3	222	19		
	14SQ616-*						1/4		246	21		
	14SQ624-*						3/8		342	29		
16	16SQ609-*	3	11-9	6QDC35	3 1/2	4	10	3	210	18		
	16SQ612-*						3/16		234	20		
	16SQ616-*						1/4		282	24		
	16SQ624-*						3/8		365	31		
	18SQ612-*						3/16		246	21		
18	18SQ616-*	3	11-9	6QDC35	3 1/2	4	1/4	3	294	25		
	18SQ624-*						3/8		425	36		
	20SQ612-*						3/16		300	26		
20	20SQ616-*	3	11-9	6QDC35	3 1/2	4	1/4	3	360	31		
	20SQ724-*						3 7/16		11-8	7QDC4	4	4 1/2
	24	24SQ712-*	3 7/16	11-8	7QDC4	4	4 1/2	3/16	4	410	37	
24SQ716-*		1/4						510		43		
24SQ724-*		3/8						595		50		

-* R For Right Hand
-* L For Left Hand

Coupling Bolts

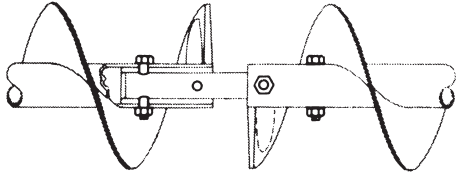

Conveyor coupling bolts are manufactured from special analysis high-torque steel. Close tolerance for a minimum of wear. Lock nuts are furnished with each bolt.

Coupling Diameter	Outside Pipe Diameter	Bolt Size	Part Number Standard	Weight Each (lb)
1	1 5/8	3/8 × 2 1/16	CCB2	.13
1 1/2	2 3/8	1/2 × 3	CCB3	.2
2	2 7/8	5/8 × 3 5/8	CCB4	.45
2 7/16	3 1/2	5/8 × 4 3/8	CCB5	.5
3	4	3/4 × 5	CCB6	.85
3	4 1/2	3/4 × 5 1/2	CCB6A	.9
3 7/16	4 1/2	7/8 × 5 1/2	CCB7	1.29

Internal Collar

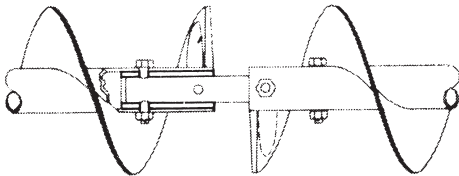

Internal collars are made from seamless tubing machined for a press fit in the conveyor pipe. When installed at the factory collars are jig drilled and plug welded into the pipe. No drilling in replacement collars is furnished allowing for field drilling to match existing bolt holes.

Coupling Diameter	Inside Pipe Diameter	Part Number Standard	Weight Each (lb)
1	1 1/4	CIC2	.58
1 1/2	2	CIC3	2.06
2	2 1/2	CIC4	2.16
2 7/16	3	CIC5	3.72
3	3 1/2	CIC6	4.03
3	4	CIC6A	8.03
3 7/16	4	CIC7	6.52

End Lugs

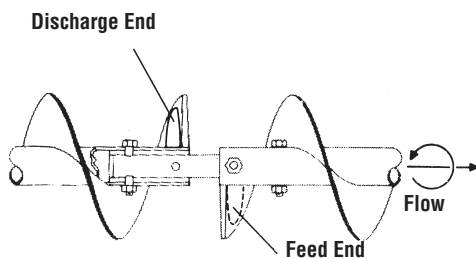

Internal collars are made from seamless tubing machined for a press fit in the conveyor pipe. When installed at the factory collars are jig drilled and plug welded into the pipe. No drilling in replacement collars is furnished allowing for field drilling to match existing bolt holes.

Conveyor Diameter	Part Number		Weight Each (lb)
	Intake End Standard	Discharge End Standard	
6	6CELI-*	6CELD-*	.06
9	9CELI-*	9CELD-*	.15
10	9CELI-*	9CELD-*	.15
12	12CELI-*	12CELD-*	.2
14	12CELI-*	12CELD-*	.2
16	16CELI-*	16CELD-*	.4
18	16CELI-*	16CELD-*	.4
20	16CELI-*	16CELD-*	.4
24	16CELI-*	16CELD-*	.4

-* R For Right Hand
-* L For Left Hand

Shaft



Coupling Shafts



Coupling Part

CC — Coupling Shaft Std.*
 CCC — Close Coupling Shaft
 CHE — Hanger End Shaft*

Coupling Diameter

2 — 1" 5 — 2 7/16"
 3 — 1 1/2" 6 — 3"
 4 — 2" 7 — 3 7/16"

* Add suffix H if Hardened

<p>COUPLING</p>		<p>Conveyor couplings are used to join individual lengths of conveyor screws and allow for rotation within the hanger bearing. C-1045 steel couplings are normally furnished; however couplings with hardened bearing surfaces may be furnished where highly abrasive materials are being conveyed. Jig drilling allows for ease of installation.</p>
<p>CLOSE</p>		<p>Close couplings are used to adjoin conveyor screws where no hanger is required. Jig drilling allows for ease of installation.</p>

Drive & End Shafts



Drive Shaft Number

1 — #1 Drive Shaft Only
 2 — #2 Single Bearing Pedestal
 3 — #3 Double Bearing Pedestal

Type

CD — Drive Shaft
 CE — End Shaft

Coupling Diameter

2 — 1" 5 — 2 7/16"
 3 — 1 1/2" 6 — 3"
 4 — 2" 7 — 3 7/16"

Bearing Type

BB — Ball
 RB — Roller

Seal Type

(Delete if without seal)
 P — Plate
 W — Waste Pack

<p>END</p>		<p>End shafts serve only to support the end conveyor section and are therefore usually supplied in cold rolled steel. End shafts are jig drilled for ease of assembly and close diametral tolerances are held for proper bearing operation.</p>
<p>HANGER END</p>		<p>Hanger end shafts are designed to connect only one conveyor section to a hanger bearing. These shafts may also be used in pairs to divide an excessively long conveyor assembly between two drives.</p>
<p>#1 DRIVE</p>		<p>No. 1 drive shafts are normally used where standard end plates are furnished. Jig drilling allows for ease of installation.</p>
<p>SPECIAL DRIVE</p>		<p>Length, bearing location, seals and keyway location and size as required.</p>

No. 1 drive shafts are normally used where standard end plates are furnished. Jig drilling allows for ease of installation.

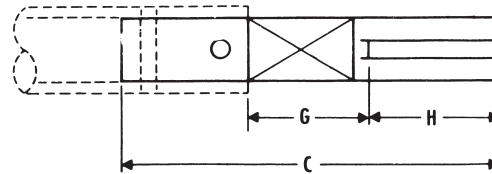

No. 1 Drive Shaft Used Without Seal*

Bronze Bearing						Ball Bearing					
Shaft Diameter	Part Number	C	G	H	Weight	Shaft Diameter	Part Number	C	G	H	Weight
1	1CD2B	9 1/2	3 1/2	3	2.0	1	1CD2BB	9	3	3	1.8
1 1/2	1CD3B	12 3/4	4 3/4	3 1/4	6.3	1 1/2	1CD3BB	11 1/2	3 1/2	3 1/4	5.6
2	1CD4B	15	5 3/4	4 1/2	13.3	2	1CD4BB	13 1/8	3 7/8	4 1/2	11.5
2 7/16	1CD5B	17 3/8	7	5 1/2	21.0	2 7/16	1CD5BB	15 1/8	4 3/4	5 1/2	18.0
3	1CD6B	19 1/8	8 1/8	6	37.0	3	1CD6BB	16 5/8	5 5/8	6	32.0
3 7/16	1CD7B	23	9	7 1/4	60.4	3 7/16	1CD7BB	20 5/8	6 5/8	7 1/4	52.5

*Consult Factory

No. 1 Drive Shaft Used With Plate or Product Drop Out Seals*

Bronze Bearing						Ball Bearing					
Shaft Diameter	Part Number	C	G	H	Weight	Shaft Diameter	Part Number	C	G	H	Weight
1	1CD2B-P	10	4	3	2.1	1	1CD2BB-P	9 1/2	3 1/2	3	2.0
1 1/2	1CD3B-P	13 1/4	5 1/4	3 1/4	6.6	1 1/2	1CD3BB-P	12 3/8	4 3/8	3 1/4	6.2
2	1CD4B-P	15 1/4	6 1/4	4 1/2	14.1	2	1CD4BB-P	14	4 3/4	4 1/2	12.5
2 7/16	1CD5B-P	18 3/8	8	5 1/2	24.3	2 7/16	1CD5BB-P	15 7/8	5 1/2	5 1/2	21.0
3	1CD6B-P	19 5/8	8 5/8	6	38.0	3	1CD6BB-P	17 1/2	6 1/2	6	35.0
3 7/16	1CD7B-P	24 1/8	10 1/8	7 1/4	61.0	3 7/16	1CD7BB-P	21 1/2	7 1/2	7 1/4	56.5

*Consult Factory

No. 1 Drive Shaft Used With Waste Pack Seal*

Bronze Bearing						Ball Bearing					
Shaft Diameter	Part Number	C	G	H	Weight	Shaft Diameter	Part Number	C	G	H	Weight
1	1CD2B-W	11	4 1/4	3	2.2	1	1CD2BB-W	10 1/2	3 3/4	3.0	2.0
1 1/2	1CD3B-W	14 1/2	6 1/2	3 1/4	7.2	1 1/2	1CD3BB-W	13 1/4	5 1/4	3.3	6.4
2	1CD4B-W	16 3/4	7 1/4	4 1/2	14.9	2	1CD4BB-W	14 7/8	5 5/8	4.5	13.0
2 7/16	1CD5B-W	19 1/8	8 3/4	5 1/2	23.3	2 7/16	1CD5BB-W	16 7/8	6 1/2	5.5	20.5
3	1CD6B-W	20 7/8	9 7/8	6	40.5	3	1CD6BB-W	18 3/8	7 3/8	6.0	35.5
3 7/16	1CD7B-W	25 7/8	11 7/8	7 1/4	66.3	3 7/16	1CD7BB-W	22 7/8	8 7/8	7.3	58.4

Shaft length allows for 1/2 hanger bearing length as clearance between end plate and screw

*Consult Factory

No. 2 and No. 3 Drive Shafts



No. 2 Drive Shaft

No. 2 drive shafts are used where pedestal type trough ends with single bearing are furnished. Jig drilling allows for ease of installation.

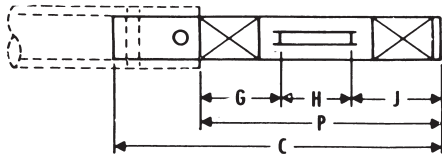

Shaft Diameter	Part Number	C	G	H	J	P	Weight
1	2CD2	11	3 1/4	2 1/4	2 1/2	8	2.5
1 1/2	2CD3	16 1/2	5	3 1/4	3 1/2	11 3/4	8.3
2	2CD4	18 3/4	5 1/4	4 1/4	4 1/2	14	17.0
2 7/16	2CD5	21 7/8	6	5 1/2	5 1/2	17	29.0
3	2CD6	23 1/2	6 1/2	5 1/2	6 1/2	18 1/2	49.0
3 7/16	2CD7	27	6 3/4	6	7 1/2	20 1/4	75.0

No. 3 Drive Shaft

No. 3 drive shafts are used where pedestal type trough ends with double bearings are furnished. Jig drilling allows for ease of installation.

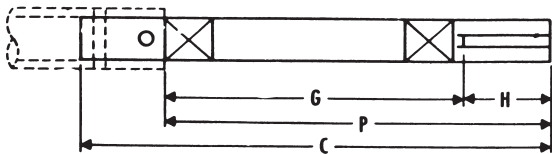

Shaft Diameter	Part Number	C	G	H	P	Weight
1	3CD2	15 1/2	9 1/4	3	12 1/4	3
1 1/2	3CD3	20 1/4	12 1/2	3 1/4	15 3/4	10
2	3CD4	22	12 3/4	4 1/2	17 1/4	21
2 7/16	3CD5	24 5/8	14 1/4	5 1/2	19 3/4	36
3	3CD6	25 7/8	14 3/4	6	20 3/4	62
3 7/16	3CD7	29 7/8	15 7/8	7 1/4	23 1/8	95

Drive Shaft Keyways

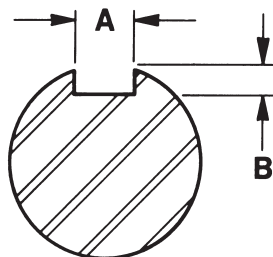

Shaft Diameter	A	B
1	1/4	1/8
1 1/2	3/8	3/16
2	1/2	1/4
2 7/16	5/8	5/16
3	3/4	3/8
3 7/16	7/8	7/16

Coupling

Conveyor couplings are used to join individual lengths of conveyor screws and allow for rotation within the hanger bearing. Mild steel couplings are normally furnished; however induction hardened bearing area couplings may be furnished where highly abrasive materials are being conveyed. Jig drilling allows for ease of installation.

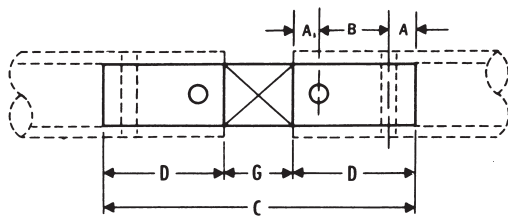

Shaft Diameter	Part Number*	A ₁	A	B	C	D	G	Weight
1	CC2	1/2	1/2	2	7 1/2	3	1 1/2	1.5
1 1/2	CC3	7/8	7/8	3	11 1/2	4 3/4	2	5.6
2	CC4	7/8	7/8	3	11 1/2	4 3/4	2	9.8
2 7/16	CC5	15/16	15/16	3	12 13/16	4 7/8	3	15.4
3	CC6	1	1	3	13	5	3	23.8
3 7/16	CC7	1 1/2	1 1/4	4	17 1/2	6 3/4	4	44.5

*Add — H for Hardened Shaft.

Shaft is induction hardened in bearing area only to 40-50 RC.

Close Coupling

Close couplings are used to adjoin conveyor screws where no hanger is required. Jig drilling allows for ease of installation.

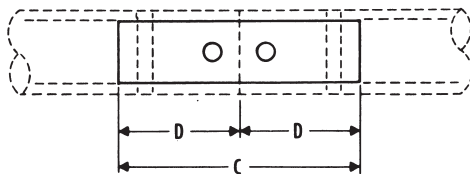

Shaft Diameter	Part Number*	C	D	Weight
1	CCC2	6	3	1.3
1 1/2	CCC3	9 1/2	4 3/4	4.8
2	CCC4	9 1/2	4 3/4	8.5
2 7/16	CCC5	9 3/4	4 7/8	13.0
3	CCC6	10	5	20.0
3 7/16	CCC7	13 1/2	6 3/4	37.0

Hanger End

Hanger end shafts are designed to connect only one conveyor section to a hanger bearing. These shafts may also be used in pairs to divide an excessively long conveyor assembly between two drives.

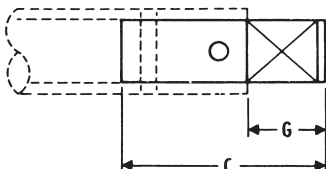

Shaft Diameter	Part Number*	C	G	Weight
1	CHE2	4 5/8	1 5/8	1.0
1 1/2	CHE3	6 7/8	2 1/8	3.5
2	CHE4	6 7/8	2 1/8	6.2
2 7/16	CHE5	8 1/8	3 1/4	10.6
3	CHE6	8 1/4	3 1/4	16.5
3 7/16	CHE7	11 1/4	4 1/4	29.7

*Add — H for Hardened Shaft

Shaft is induction hardened in bearing area only to 40-50 RC.

End Shaft



End shafts serve only to support the end conveyor section and are therefore usually supplied in cold rolled steel. End shafts are jig drilled for ease of assembly and close diametrical tolerances are held for proper bearing operation.

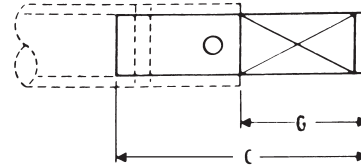

End Shaft Used Without Seal**

Bronze Bearing					Ball Bearing				
Shaft Diameter	Part Number*	C	G	Weight	Shaft Diameter	Part Number*	C	G	Weight
1	CE2B	6 1/2	3 1/2	1.4	1	CE2BB	6	3	1.2
1 1/2	CE3B	9 1/4	4 1/2	4.5	1 1/2	CE3BB	8 1/4	3 1/2	3.8
2	CE4B	10 1/4	5 1/2	9.0	2	CE4BB	8 5/8	3 7/8	7.5
2 7/16	CE5B	11 7/8	7	15.4	2 7/16	CE5BB	9 5/8	4 3/4	12.4
3	CE6B	13 1/8	8 1/8	25.6	3	CE6BB	10 5/8	5 5/8	20.8
3 7/16	CE7B	16 3/8	9 5/8	42.4	3 7/16	CE7BB	13 3/8	6 5/8	34.4

*Add - H for Hardened Shaft.

**Shaft length allows for 1/2 hanger bearing length, clearance between end plate and screw.

Consult Factory

End Shaft Used With Plate or Product Drop Out Seal**

Bronze Bearing					Ball Bearing				
Shaft Diameter	Part Number*	C	G	Weight	Shaft Diameter	Part Number*	C	G	Weight
1	CE2B-P	7	4	1.5	1	CE2BB-P	6 1/2	3 1/2	1.4
1 1/2	CE3B-P	10 1/4	5 1/2	5.1	1 1/2	CE3BB-P	9	4 5/16	4.5
2	CE4B-P	11 1/4	6 1/2	10.0	2	CE4BB-P	9 3/8	4 5/8	8.3
2 7/16	CE5B-P	12 7/8	8	17.0	2 7/16	CE5BB-P	10 1/8	5 5/16	13.1
3	CE6B-P	13 5/8	8 5/8	29.8	3	CE6BB-P	11 1/2	6 1/2	23.0
3 7/16	CE7B-P	16 7/8	10 1/8	44.0	3 7/16	CE7BB-P	14 1/8	7 3/8	37.1

*Add - H for Hardened Shaft.

**Shaft length allows for 1/2 hanger bearing length, clearance between end plate and screw.

Consult Factory

End Shaft Used With Waste Pack Seal**

Bronze Bearing					Ball Bearing				
Shaft Diameter	Part Number*	C	G	Weight	Shaft Diameter	Part Number*	C	G	Weight
1	CE2B-W	8	5	1.6	1	CE2BB-W	7 1/2	3 3/4	1.4
1 1/2	CE3B-W	11	6 1/4	5.2	1 1/2	CE3BB-W	10	5 1/4	4.8
2	CE4B-W	12	7 1/4	10.4	2	CE4BB-W	10 3/8	5 5/8	9.0
2 7/16	CE5B-W	13 5/8	8 3/4	17.6	2 7/16	CE5BB-W	11 3/8	6 1/2	14.8
3	CE6B-W	14 7/8	9 7/8	28.2	3	CE6BB-W	12 3/8	7 3/8	24.0
3 7/16	CE7B-W	18 5/8	11 7/8	48.0	3 7/16	CE7BB-W	15 5/8	8 7/8	40.2

*Add - H for Hardened Shaft.

**Shaft length allows for 1/2 hanger bearing length, clearance between end plate and screw.

Consult Factory

<p>STYLE 226</p>		<p>No. 226 hangers are designed for flush mounting inside the trough permitting dust-tight or weather-proof operation. This type hanger allows for minimum obstruction of material flow in high capacity conveyors. Available with friction type bearing.</p>
<p>STYLE 216</p>		<p>No. 216 hangers are designed for heavy duty applications. This hanger is flush mounted inside the trough permitting dust tight or weather proof operation. Hard iron or bronze bearings are normally furnished; however, the hanger can be furnished with other bearings.</p>
<p>STYLE 220</p>		<p>No. 220 hangers are designed for mount on top of the trough flanges and may be used where dust-tight or weather proof operation is not required. This type hanger allows for minimum obstruction of material flow in high capacity conveyors. Available with friction type bearing.</p>
<p>STYLE 230</p>		<p>No. 230 hangers are designed for heavy duty applications where mounting on top of the trough flanges is required. Hard iron or bronze bearings are normally furnished; however, other bearings are available.</p>
<p>STYLE 316</p>		<p>No. 316 hangers are designed for heavy duty use in conveyors where abnormal heat requires unequal expansion between the screw and conveyor trough. Hard iron or bronze bearings are normally furnished; however, this hanger can be furnished with other bearings.</p>
<p>STYLE 326</p>		<p>No. 326 hangers are designed to permit minimum obstruction of material flow and are used in conveyors where abnormal heat requires unequal expansion between the screw and the conveyor trough. Hard iron or bronze bearings are normally furnished, but other type bearings are available.</p>

Hangers



<p>STYLE 60</p>		<p>No. 60 hangers are furnished with a heavy duty, permanently lubricated and sealed, self aligning ball bearing which permits temperatures up to 245° F. and will allow for up to 4° shaft misalignment. This hanger is mounted on top of the trough flanges. Grease fitting can be furnished if specified.</p>
<p>STYLE 70</p>		<p>No. 70 hangers are furnished with a heavy duty, permanently lubricated and sealed, self aligning ball bearing which permit temperatures up to 245° F. and will allow for up to 4° shaft misalignment. This hanger is mounted inside the trough. Grease fittings can be furnished if specified.</p>
<p>STYLE 30</p>		<p>No. 30 hangers are designed for side mounting within the conveyor trough on the noncarrying side and permit a minimum of obstruction of material flow. Available with friction type bearing.</p>
<p>STYLE 216F</p>		<p>No. 216F hangers are designed for heavy duty applications and are mounted inside of flared trough. Hard iron or bronze bearings are normally furnished; however, other bearings are available.</p>
<p>STYLE 19B</p>		<p>The No. 19B hanger is similar in construction to the No. 18B except they are mounted on top of the trough angles. Built-in ledges provide supports for the ends of the cover. They are streamline in design and permit free passage of the material. They are regularly furnished with Arguto oil impregnated wood, hard iron, bronze, or other special caps can be furnished.</p>
<p>AIR-PURGED HANGER</p>		<p>Air-Purged hangers are recommended when handling dusty and abrasive materials which contribute to shutdowns and hanger bearing failures. Air-swept hangers are available for 9"-24" conveyors. They should not be used when handling hot materials (over 250° F) or wet sticky materials or when handling non abrasive materials when an inexpensive hanger will do the job satisfactorily. In service, air-purged hangers deliver relatively trouble-free operation. They help solve noise nuisance problems, and they help reduce power requirement because of the low coefficient of friction. Maximum trough loading should not exceed 15%. The air, at approximately 1-1/4 PSI enters the housing at the top, passes over and around the bearing, and is dissipated around the coupling shaft on both sides of the housing. Thus the bearing is protected from dust and the material in the trough at all times. Only 3 to 7 cu. ft. of air per minute is required to keep each hanger bearing clean.</p>

Style 220

Conveyor couplings are used to join individual lengths of conveyor screws and allow for rotation within the hanger bearing. Mild steel couplings are normally furnished; however induction hardened bearing area couplings may be furnished where highly abrasive materials are being conveyed. Jig drilling allows for ease of installation.

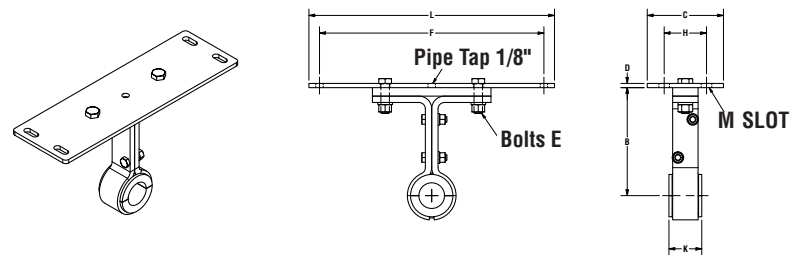

Conveyor Diameter	Coupling Size	Part Number*	B	C	D	E	F	H	K	L	M Slot	Weight Each
4	1	4CH2202	3 5/8	3 1/2	3/16	1/4	6 1/2	2	1 1/2	7 1/4	5/16 × 3/4	5
6	1 1/2	6CH2203	4 1/2	4 1/2	3/16	3/8	8 3/4	2 1/2	2	9 3/4	7/16 × 1 1/16	7
9	1 1/2	9CH2203	6 1/8	4 1/2	1/4	3/8	12 1/4	2 1/2	2	13 1/2	7/16 × 1 1/16	9
	2	9CH2204	6 1/8	4 1/2	1/4	3/8	12 1/4	2 1/2	2	13 1/2		11
10	1 1/2	10CH2203	6 3/8	4 1/2	1/4	3/8	13 1/4	2 1/2	2	14 1/2	7/16 × 1 1/16	10
	2	10CH2204	6 3/8	4 1/2	1/4	3/8	13 1/4	2 1/2	2	14 1/2		12
12	2	12CH2204	7 3/4	5	3/8	1/2	15 3/4	2 1/2	2	17 1/2	9/16 × 1 5/16	16
	2 7/16	12CH2205	7 3/4	5	3/8	1/2	15 3/4	2 1/2	3	17 1/2		21
	3	12CH2206	7 3/4	5	3/8	1/2	15 3/4	2 1/2	3	17 1/2		28
14	2 7/16	14CH2205	9 1/4	5	1/2	1/2	17 3/4	2 1/2	3	19 1/2	9/16 × 1 5/16	26
	3	14CH2206	9 1/4	5	1/2	1/2	17 3/4	2 1/2	3	19 1/2		33
16	3	16CH2206	10 5/8	5	1/2	1/2	19 3/4	2 1/2	3	21 1/2	9/16 × 1 5/16	39
	3	16CH2206	10 5/8	5	1/2	1/2	19 3/4	2 1/2	3	21 1/2		39
18	3	18CH2206	12 1/8	6	1/2	5/8	22 1/4	3 1/2	3	24 1/2	11/16 × 13/16	41
	3 7/16	18CH2207	12 1/8	6	1/2	5/8	22 1/4	3 1/2	4	24 1/2		49
20	3	20CH2206	13 1/2	6	1/2	5/8	24 1/4	3 1/2	3	26 1/2	11/16 × 13/16	43
	3 7/16	20CH2207	13 1/2	6	1/2	5/8	24 1/4	3 1/2	4	26 1/2		51
24	3 7/16	24CH2207	16 1/2	6	5/8	5/8	28 1/4	3 1/2	4	30 1/2	11/16 Hole	57

*Refer to Page H-99 for bearings. For hangers with oil pipe add -0 to part number

Style 226

No. 226 hangers are designed for flush mounting inside the trough permitting dust-tight or weather-proof operation. This type hanger allows for minimum obstruction of material flow in high capacity conveyors. Also available with friction type bearing.

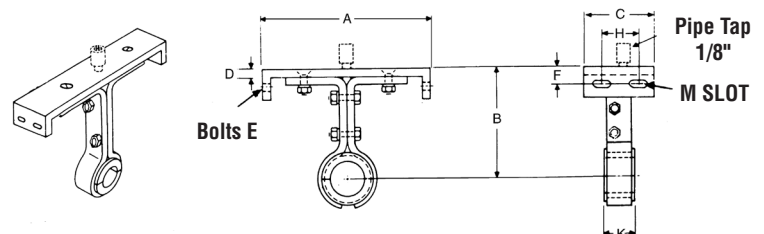

Conveyor Diameter	Coupling Size	Part Number*	A	B	C	D	E	F	H	K	M Slot	Weight Each
4	1	4CH2262	5	3 5/8	3 1/2	3/16	1/4	11/16	2	1 1/2	5/16 × 5/16	5
6	1 1/2	6CH2263	7	4 1/2	4 1/2	3/16	3/8	3/4	2 1/2	2	7/16 × 1 1/16	7
9	1 1/2	9CH2263	10	6 1/8	4 1/2	1/4	3/8	1	2 1/2	2	7/16 × 1 1/16	9
	2	9CH2264	10	6 1/8	4 1/2	1/4	3/8	1				11
10	1 1/2	10CH2263	11	6 3/8	4 1/2	1/4	3/8	1	2 1/2	2	7/16 × 1 1/16	10
	2	10CH2264	11	6 3/8	4 1/2	1/4	3/8	1				12
12	2	12CH2264	13	7 3/4	5	3/8	1/2	1 1/4	2 1/2	3	9/16 × 1 5/16	16
	2 7/16	12CH2265	13	7 3/4	5	3/8	1/2	1 1/4				21
	3	12CH2266	13	7 3/4	5	3/8	1/2	1 1/4				28
14	2 7/16	14CH2265	15	9 1/4	5	1/2	1/2	1 3/8	2 1/2	3	9/16 × 1 5/16	26
	3	14CH2266	15	9 1/4	5	1/2	1/2	1 3/8				33
16	3	16CH2266	17	10 5/8	5	1/2	1/2	1 3/8	2 1/2	3	9/16 × 1 5/16	39
	3	16CH2266	17	10 5/8	5	1/2	1/2	1 3/8				39
18	3	18CH2266	19	12 1/8	6	1/2	5/8	1 1/2	3 1/2	3	11/16 × 1 11/16	41
	3 7/16	18CH2267	19	12 1/8	6	1/2	5/8	1 1/2				49
20	3	20CH2266	21	13 1/2	6	1/2	5/8	1 1/2	3 1/2	4	11/16 × 1 11/16	43
	3 7/16	20CH2267	21	13 1/2	6	1/2	5/8	1 1/2				51
24	3 7/16	24CH2267	25	16 1/2	6	5/8	5/8	1 5/8	3 1/2	4	11/16 × 1 11/16	57

*Refer to Page H-99 for bearings. For hangers with oil pipe add -0 to part number

Hangers



Style 216

No. 216 hangers are designed for heavy duty applications. This hanger is flush mounted inside the trough permitting dust tight or weather proof operation. Hard iron or bronze bearings are normally furnished; however, the hanger can be furnished with other bearings.

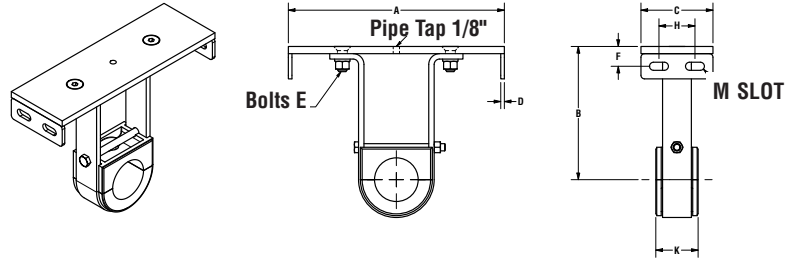

Conveyor Diameter	Coupling Size	Part Number*	A	B	C	D	E	F	H	K	M Slot	Weight Each
6	1 1/2	6CH2163	7	4 1/2	4 1/2	3/16	3/8	3/4	2 1/2	2	7/16 × 1 1/16	5
9	1 1/2	9CH2163	10	6 1/8	4 1/2	1/4	3/8	1	2 1/2	2	7/16 × 1 1/16	7
	2	9CH2164	10	6 1/8	4 1/2	1/4	3/8	1	2 1/2	2		9
10	1 1/2	10CH2163	11	6 3/8	4 1/2	1/4	3/8	1	2 1/2	2	7/16 × 1 1/16	8
	2	10CH2164	11	6 3/8	4 1/2	1/4	3/8	1	2 1/2	2		10
12	2	12CH2164	13	7 3/4	5	3/8	1/2	1 1/4	2 1/2	2	9/16 × 1 5/16	14
	2 7/16	12CH2165	13	7 3/4	5	3/8	1/2	1 1/4	2 1/2	3		18
	3	12CH2166	13	7 3/4	5	3/8	1/2	1 1/4	2 1/2	3		21
14	2 7/16	14CH2165	15	9 1/4	5	1/2	1/2	1 3/8	2 1/2	3	9/16 × 1 5/16	23
	3	14CH2166	15	9 1/4	5	1/2	1/2	1 3/8	2 1/2	3		25
16	3	16CH2166	17	10 5/8	5	1/2	1/2	1 3/8	2 1/2	3	9/16 × 1 5/16	28
	3	18CH2166	19	12 1/8	6	1/2	5/8	1 1/2	3 1/2	3		11/16 × 1 11/16
18	3 7/16	18CH2167	19	12 1/8	6	1/2	5/8	1 1/2	3 1/2	4	44	
	20	3	20CH2166	21	13 1/2	6	1/2	5/8	1 1/2	3 1/2	3	11/16 × 1 11/16
3 7/16		20CH2167	21	13 1/2	6	1/2	5/8	1 1/2	3 1/2	4	47	
24	3 7/16	24CH2167	25	16 1/2	6	5/8	5/8	1 5/8	3 1/2	4	11/16 × 1 11/16	53

*Refer to Page H-99 for bearings. For hangers with oil pipe add -0 to part number

Style 230

No. 230 hangers are designed for heavy duty applications where mounting on top of the trough flange is required. Hard iron or bronze bearings are normally furnished; however, other bearings are available.

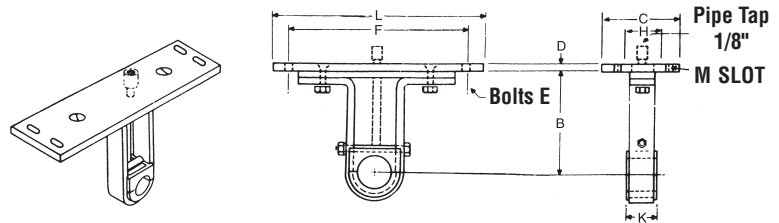

Conveyor Diameter	Coupling Size	Part Number*	B	C	D	E	F	H	K	L	M Slot	Weight Each
6	1 1/2	6CH2303	4 1/2	4 1/2	3/16	3/8	8 3/4	2 1/2	2	9 3/4	7/16 × 1 1/16	6
9	1 1/2	9CH2303	6 1/8	4 1/2	1/4	3/8	12 1/4	2 1/2	2	13 1/2	7/16 × 1 1/16	8
	2	9CH2304	6 1/8	4 1/2	1/4	3/8	12 1/4	2 1/2	2	13 1/2		10
10	1 1/2	10CH2303	63/8	4 1/2	1/4	3/8	13 1/4	2 1/2	2	14 1/2	7/16 × 1 1/16	9
	2	10CH2304	63/8	4 1/2	1/4	3/8	13 1/4	2 1/2	2	14 1/2		11
12	2	12CH2304	7 3/4	5	3/8	1/2	15 3/4	2 1/2	2	17 1/2	9/16 × 1 5/16	15
	2 7/16	12CH2305	7 3/4	5	3/8	1/2	15 3/4	2 1/2	3	17 1/2		20
	3	12CH2306	7 3/4	5	3/8	1/2	15 3/4	2 1/2	3	17 1/2		25
14	2 7/16	14CH2305	9 1/4	5	1/2	1/2	17 3/4	2 1/2	3	19 1/2	9/16 × 1 5/16	24
	3	14CH2306	9 1/4	5	1/2	1/2	17 3/4	2 1/2	3	19 1/2		29
16	3	16CH2306	10 5/8	5	1/2	1/2	19 3/4	2 1/2	3	21 1/2	9/16 × 1 5/16	35
	3	18CH2306	12 1/8	6	1/2	5/8	22 1/4	3 1/2	3	24 1/2		1 1/16 × 13/16
18	3 7/16	18CH2307	12 1/8	6	1/2	5/8	22 1/4	3 1/2	4	24 1/2	47	
	20	3	20CH2306	13 1/2	6	1/2	5/8	24 1/4	3 1/2	3	26 1/2	1 1/16 × 13/16
3 7/16		20CH2307	13 1/2	6	1/2	5/8	24 1/4	3 1/2	4	26 1/2	49	
24	3 7/16	24CH2307	16 1/2	6	5/8	5/8	28 1/4	3 1/2	4	30 1/2	1 1/16 Holes	55

*Refer to Page H-99 for bearings. For hangers with oil pipe add -0 to part number

Style 316

No. 316 hangers are designed for heavy duty use in conveyors where abnormal heat requires unequal expansion between the screw and conveyor trough. Hard iron or bronze bearings are normally used; however, this hanger can be furnished with other bearings.

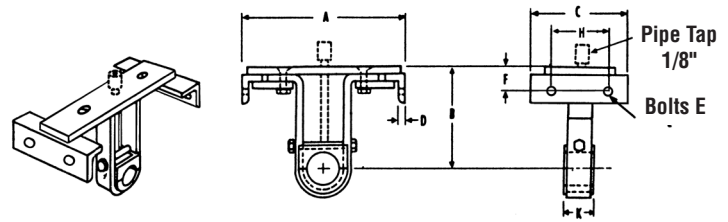

Style 326

No. 326 hangers are designed to permit minimum obstruction of material flow and are used in conveyors where abnormal heat requires unequal expansion between the screw and the conveyor trough. Hard iron or bronze bearings are normally used, but other type bearings are available.

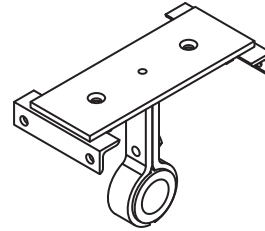

Conveyor Diameter	Coupling Size	Part Number		A	B	C	D	E	F	H	K
		Style 316*	Style 326*								
6	1 1/2	6CH3163	6CH3263	7	4 1/2	6	3/16	3/8	3/4	4 1/2	2
	2	9CH3163	9CH3263	10	6 1/8	6	3/16	3/8	1	4 1/2	2
9	1 1/2	9CH3164	9CH3264	10	6 1/8	6	3/16	3/8	1	4 1/2	2
	2	10CH3163	10CH3263	11	6 3/8	6	3/16	3/8	1	4 1/2	2
10	1 1/2	10CH3164	10CH3264	11	6 3/8	6	3/16	3/8	1	4 1/2	2
	2	12CH3164	12CH3264	13	7 3/4	6 1/2	1/4	1/2	1 1/4	5	2
12	2 7/16	12CH3165	12CH3265	13	7 3/4	6 1/2	1/4	1/2	1 1/4	5	3
	3	12CH3166	12CH3266	13	7 3/4	6 1/2	1/4	1/2	1 1/4	5	3
14	2 7/16	14CH3165	14CH3265	15	9 1/4	6 1/2	1/4	1/2	1 3/8	5	3
	3	14CH3166	14CH3266	15	9 1/4	6 1/2	1/4	1/2	1 3/8	5	3
16	3	16CH3166	16CH3266	17	10 5/8	6 1/2	1/4	1/2	1 3/8	5	3
	3	18CH3166	18CH3266	19	12 1/8	7	1/4	5/8	1 5/8	5 1/4	3
18	3 7/16	18CH3167	18CH3267	19	12 1/8	7	1/4	5/8	1 5/8	5 1/4	4
	3	20CH3166	20CH3266	21	13 1/2	7	1/4	5/8	1 5/8	5 1/4	3
20	3 7/16	20CH3167	20CH3267	21	13 1/2	7	1/4	5/8	1 5/8	5 1/4	4
	3 7/16	24CH3167	24CH3267	25	16 1/2	7	1/4	5/8	1 3/4	5 1/4	4

*Refer to Page H-99 for bearings. For hangers with oil pipe add -0 to part number

Air-Purged Hanger

Air purged hangers are recommended when handling dusty and abrasive materials which contribute to shut-downs and hanger bearing failures. They should not be used when handling hot materials (over 250°F) or wet sticky materials or when handling nonabrasive materials when an inexpensive hanger will do the job satisfactorily. Maximum trough loading should not exceed 15%. The air, at approximately 11/4 PSI, enters the housing at the top, passes over and around the bearing, and is dissipated around the coupling shaft on both sides of the housing. Only 3 to 7 cu. ft. of air per minute is required to keep each hanger bearing clean.

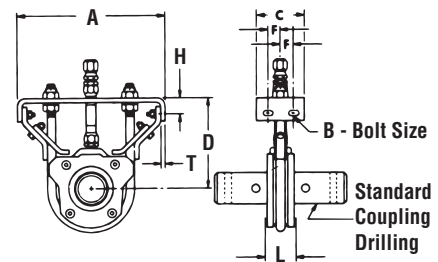
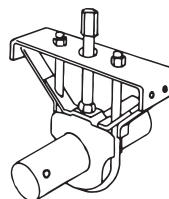

Conveyor Diameter	Coupling Size	Part Number		A	B	C	D	F	H	L	T
		Style 316*	Style 326*								
9	9CHAPH3	1 1/2	15	10	3/8	4 1/2	6 1/8	1 1/4	1	2	1/4
	9CHAPH4	2	20								
12	12CHAPH4	2	30	13	1/2	5	7 1/4	1 1/4	1 1/4	2	1/4
	12CHAPH5	2 7/16	52								
	12CHAPH6	3	68								
14	14CHAPH5	2 7/16	60	15	1/2	5	9 1/4	1 1/4	1 3/8	3	3/8
	14CHAPH6	3	74								
16	16CHAPH6	3	77	17	1/2	5	10 5/8	1 1/4	1 3/8	3	1/8
18	18CHAPH6	3	91	19	5/8	6	12 1/8	1 3/4	1 5/8	3	1/2
20	20CHAPH6	3	105	21	5/8	6	13 1/2	1 3/4	1 3/8	3	1/2
	20CHAPH7	3 7/16	140								
24	24CHAPH7	3 7/16	155	25	5/8	6	16 1/2	1 3/4	1 5/8	4	1/2

*Refer to Page H-99 for bearings. For hangers with oil pipe add -0 to part number

Hangers



Style 30

No. 30 hangers are designed for side mounting within the conveyor trough on the non-carrying side and permit a minimum of obstruction of material flow. Available with friction type bearing.

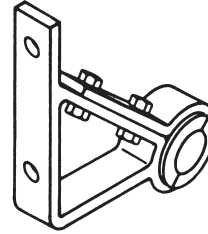

Conveyor Diameter	Coupling Size	Part Number*	A	B	C	D	E	F	G	H	Weight Each
6	1 1/2	6CH303	3 1/2	4 1/4	1 1/2	3/8	5/16	3 1/8	1/2	2	3
9	1 1/2	9CH303	5	5 7/8	1 1/2	3/8	3/8	4 1/4	1/2	2	6
	2	9CH304	5	5 7/8	1 1/2	1/2	3/8	4 1/4	1/2	2	8
10	1 1/2	10CH303	5 1/2	6 3/8	1 1/2	3/8	1/2	4 3/8	3/4	2	8
	2	10CH304	5 1/2	6 3/8	1 1/2	1/2	1/2	4 3/8	3/4	2	9
12	2	12CH304	6 1/2	7 1/2	1 1/2	1/2	1/2	5 1/2	3/4	2	12
	2 7/16	12CH305	6 1/2	7 1/2	2	1/2	1/2	5 1/2	3/4	3	18
	3	12CH306	6 1/2	7 1/2	2	5/8	1/2	5 1/2	3/4	3	20
14	2 7/16	14CH305	7 1/2	9	2	1/2	5/8	6 7/8	7/8	3	20
	3	14CH306	7 1/2	9	2	5/8	5/8	6 7/8	7/8	3	22
16	3	16CH306	8 1/2	10 3/8	2	5/8	5/8	8	1	3	32
18	3	18CH306	9 1/2	11 7/8	2	3/4	5/8	8	1 1/4	3	30
	3 7/16	18CH307	9 1/2	11 7/8	3	3/4	5/8	8	1 1/4	4	33
20	3	20CH306	10 1/2	13 1/4	2	3/4	5/8	10 1/4	1 1/4	3	32
	3 7/16	20CH307	10 1/2	13 1/4	3	3/4	5/8	10 1/4	1 1/4	4	38
24	3 7/16	24CH307	12 1/2	16 1/4	3	3/4	3/4	12 3/4	1 1/2	4	46

*Refer to Page H-99 for bearings. For hangers with oil pipe add -0 to part number

Style 216F

No. 216F hangers are designed for heavy duty applications and are mounted inside of flared trough. Hard iron or bronze bearings are normally furnished; however, other bearings are available.

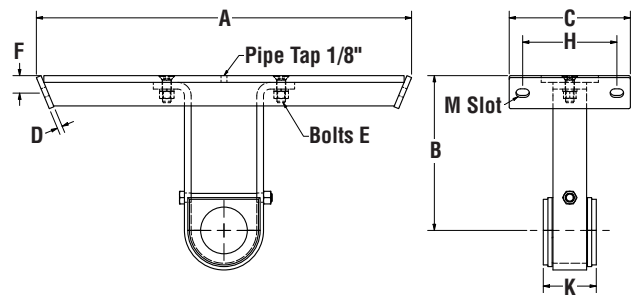
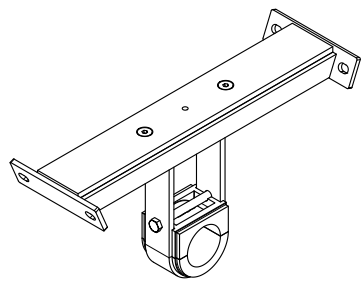

Conveyor Diameter	Coupling Size	Part Number*	A	B	C	D	E	F	H	K	Weight Each	M Slot
6	1 1/2	6CH216F3	14	7	7 1/2	1/4	3/8	7/8	6	2	9	7/16 × 3/4
9	1 1/2	9CH216F3	18	9	9	3/16	3/8	1	7	2	14	7/16 × 15/16
	2	9CH216F4									17	
12	2	12CH216F4								2	24	9/16 × 15/16
	2 7/16	12CH216F5	22	10	9	3/8	1/2	1 1/4	7	3	28	
14	3	12CH216F6									32	9/16 × 15/16
	2 7/16	14CH216F5	24	11	9	3/8	1/2	1 1/8	7	3	31	
16	3	14CH216F6									34	11/16 × 1
	3	16CH216F6	28	11 1/2	9	1/2	5/8	1 1/4	7	3	38	
18	3	18CH216F6	31	12 1/8	10	1/2	5/8	1 1/2	8	3	52	11/16 × 15/16
	3 7/16	18CH216F7								4	61	
20	3	20CH216F6	34	13 1/2	10	1/2	5/8	1 1/2	8	3	55	11/16 × 15/16
	3 7/16	20CH216F7								4	64	
24	3 7/16	24CH216F7	40	16 1/2	10	5/8	5/8	1 5/8	8	4	71	11/16 × 15/16

*Refer to Page H-99 for bearings. For hangers with oil pipe add -0 to part number

Style 60

No. 60 hangers are furnished with a heavy duty, permanently lubricated and sealed, self-aligning ball bearing which permits temperatures up to 245° F. and will allow for up to 4° shaft misalignment. This hanger is mounted on top of the trough flanges. Grease fitting can be furnished if specified.

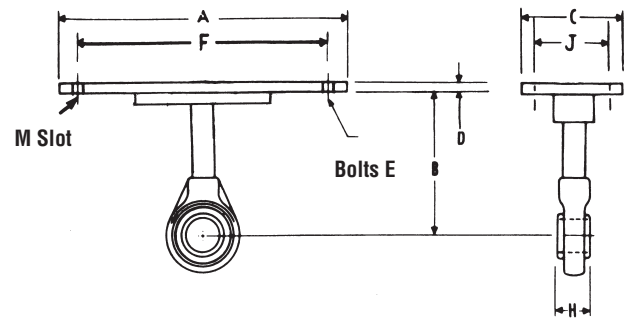
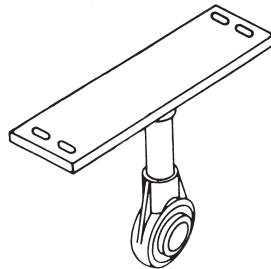

Conveyor Diameter	Coupling Size	Part Number*	A	B	C	D	E	F	H	J	Weight Each	M Slot
6	1 1/2	6CH603	9 3/4	4 1/2	4 1/2	3/16	3/8	8 3/4	1 11/16	2	7	7/16 × 11/16
9	1 1/2	9CH603	13 1/2	6 1/8	4 1/2	1/4	3/8	12 1/4	1 11/16	2 1/2	8	7/16 × 11/16
	2	9CH604	13 1/2	6 1/8	4 1/2	1/4	3/8	12 1/4	1 3/4	2 1/2	9	7/16 × 11/16
10	1 1/2	10CH603	14 1/2	6 3/8	4 1/2	1/4	3/8	13 1/4	1 11/16	2 1/2	9	7/16 × 15/16
	2	10CH604	14 1/2	6 3/8	4 1/2	1/4	3/8	13 1/4	1 3/4	2 1/2	10	7/16 × 15/16
12	2	12CH604	17 1/2	7 3/4	5	3/8	1/2	15 3/4	1 3/4	2 1/2	12	9/16 × 15/16
	2 7/16	12CH605	17 1/2	7 3/4	5	3/8	1/2	15 3/4	1 63/64	2 1/2	20	9/16 × 15/16
	3	12CH606	17 1/2	7 3/4	5	3/8	1/2	15 3/4	2 11/16	2 1/2	30	9/16 × 15/16
14	2 7/16	14CH605	19 1/2	9 1/4	5	1/2	1/2	17 3/4	1 63/64	2 1/2	21	9/16 × 15/16
	3	14CH606	19 1/2	9 1/4	5	1/2	1/2	17 3/4	2 11/32	2 1/2	32	9/16 × 15/16
16	3	16CH606	21 1/2	10 5/8	5	1/2	1/2	19 3/4	2 11/32	2 1/2	35	9/16 × 15/16
18	3	18CH606	24 1/2	12 1/8	6	1/2	5/8	22 1/4	2 11/32	3 1/2	40	11/16 × 1 11/16
20	3	20CH606	26 1/2	13 1/2	6	1/2	5/8	24 1/4	2 11/32	3 1/2	45	11/16 × 1 11/16
24	3 7/16	24CH607	30 1/2	16 1/2	6	5/8	5/8	28 1/4	2 31/64	3 1/2	58	11/16 × 1 11/16

*For hangers with oil pipe add -0 to part number

Style 70

No. 70 hangers are furnished with a heavy duty, permanently lubricated and sealed, self-aligning ball bearing which permits temperatures up to 245° F. and will allow for up to 4° shaft misalignment. This hanger is mounted inside the trough. Grease fitting can be furnished if specified.

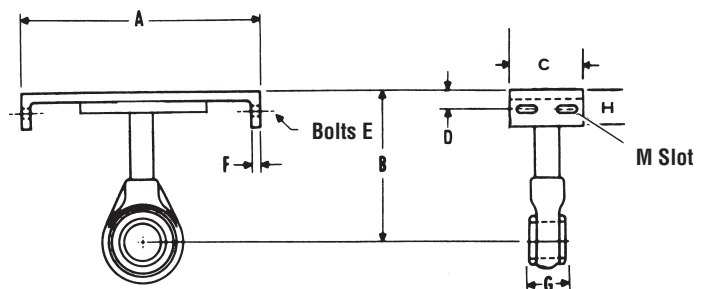

Conveyor Diameter	Coupling Size	Part Number*	A	B	C	D	E	F	G	H	Weight Each	M Slot
6	1 1/2	6CH703	7	4 1/2	4 1/2	3/4	3/8	3/16	1 11/16	1 1/2	7	7/16 × 11/16
9	1 1/2	9CH703	10	6 1/8	4 1/2	1	3/8	1/4	1 11/16	1 3/4	8	7/16 × 11/16
	2	9CH704	10	6 1/8	4 1/2	1	3/8	1/4	1 3/4	1 3/4	9	
10	1 1/2	10CH703	11	6 3/8	4 1/2	1	3/8	1/4	1 11/16	1 3/4	9	7/16 × 11/16
	2	10CH704	11	6 3/8	4 1/2	1	3/8	1/4	1 3/4	1 3/4	10	
12	2	12CH704	13	7 3/4	5	1 1/4	1/2	3/8	1 3/4	2 1/8	12	9/16 × 15/16
	2 7/16	12CH705	13	7 3/4	5	1 1/4	1/2	3/8	1 63/64	2 1/8	20	
	3	12CH706	13	7 3/4	5	1 1/4	1/2	3/8	2 11/32	2 1/8	30	
14	2 7/16	14CH705	15	9 1/4	5	1 3/8	1/2	1/2	1 63/64	2 1/4	21	9/16 × 15/16
	3	14CH706	15	9 1/4	5	1 3/8	1/2	1/2	2 11/32	2 1/4	32	
16	3	16CH706	17	10 5/8	5	1 3/8	1/2	1/2	2 11/32	2 1/4	35	9/16 × 15/16
18	3	18CH706	19	12 1/8	6	1 1/2	5/8	1/2	2 11/32	2 1/2	40	11/16 × 13/16
20	3	20CH706	21	13 1/2	6	1 1/2	5/8	1/2	2 11/32	2 1/2	45	11/16 × 13/16
24	3 7/16	24CH707	25	16 1/2	6	1 5/8	5/8	5/8	2 11/32	2 5/8	58	11/16 Holes

*For hangers with oil pipe add -0 to part number

Hangers



Style 19B

The No. 19-B Hanger is similar in construction to the No. 18-B except they are mounted on top of the trough angles. Built-in ledges provide supports for the ends of the cover. They are streamlined in design and permit free passage of the material.

Top half is furnished with bronze bearing. Bottom half can be supplied in oil impregnated wood, hard iron, or other special caps may be furnished on request.

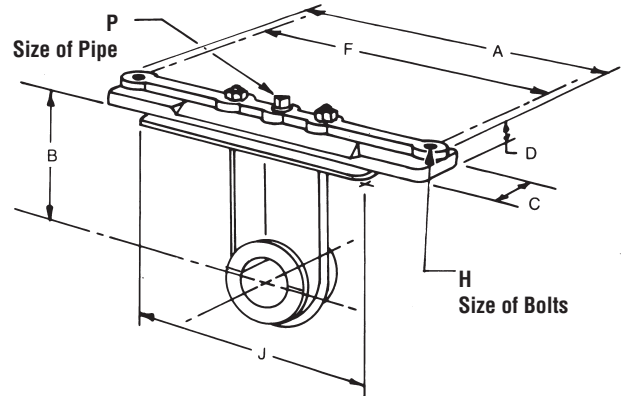
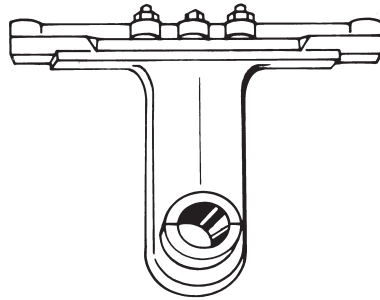

Conveyor Diameter	Coupling Size	Part Number	A	B	C	D	F	H	J	P	Weight
6	1 1/2	6CH19B3	9 7/8	4 1/2	1 7/8	7/8	8 3/4	9/16	6 1/2	1/8	8.5
9	1 1/2	9CH19B3	13 1/2	6 1/8	1 3/4	1	12 1/4	9/16	9 1/2	1/8	13.0
	2	9CH19B4	13 1/2	6 1/8	1 3/4	1	12 1/4	9/16	9 1/2	1/8	15.5
10	1 1/2	10CH19B3	14 1/2	6 3/8	1 3/4	1	13 1/4	9/16	10 1/2	1/8	14.0
	2	10CH19B4	14 1/2	6 3/8	1 3/4	1	13 1/4	9/16	10 1/2	1/8	14.0
12	2	12CH19B4	17	7 3/4	2	1 1/4	15 3/4	9/16	12 1/2	1/8	24.0
	2 7/16	12CH19B5	17	7 3/4	2 1/8	15/6	15 3/4	9/16	12 1/2	1/8	24.5
	3	12CH19B6	17	7 3/4	2 1/8	15/6	15 3/4	9/16	12 1/2	1/8	24.5
14	2 7/16	14CH19B5	19 1/4	9 1/4	3	1 1/2	17 3/4	9/16	14 1/2	1/8	37.0
	3	14CH19B6	19 1/4	9 1/4	3	1 1/2	17 3/4	9/16	14 1/4	1/8	37.0
16	3	16CH19B6	21 1/4	10 5/8	3	1 3/4	19 3/4	11/16	16 1/2	1/8	45.0
18	3	18CH19B6	23 3/4	12 1/8	3	1 5/8	22 1/4	11/16	18 1/2	1/8	48.5
20	3 7/16	20CH19B7	26 1/4	13 1/2	4	1 1/2	24 1/4	13/16	20	1/8	60.0



Screw Conveyor Hanger Bearing Selection Application

Bearing Material	Maximum Operating Temperature (°F)	Styles Available	Material FDA Complaint	Self Lube	Some Suggested Uses	Comments
<i>Martin</i> WHITE IRON	500°	220			Chemical, Cement, Aggregate	Requires hardened shaft. Can be noisy. Lubrication required in some applications.
ERTALYTE®	200°	220, 216	Yes		Food	Registered Trademark of Quadrant Engineering Products
GATKE	400°	220, 216			Chemical	Fiberglass fabric. Good for higher speeds.
<i>Martin</i> HARD IRON	500°	220		Yes	Chemical, Cement, Aggregate	Requires Hardened Shaft
CAST HARD IRON	500°	220, 216, 19B			Lime, Cement, Salt, Gypsum	Requires hardened shaft. Can be noisy. Lubrication required in some applications.
WOOD	160°	220, 216, 19B		Yes	Grain, Feed, Fertilizer	Good general purpose.
<i>Martin</i> BRONZE	850°	220		Yes	Grain, Feed, Processing	High quality bearings. High load capacity.
NYLATRON GS	250°	220, 19B		Yes	Chemical, Handling, Grain, Feed	Very low load capacity.
UHMW	225°	220, 216	Yes	Yes	Food	Material USDA approved. Does not swell in water.
STELLITE	1000°	220, 216			Chemical, Cement, Aggregate	Requires Stellite insert in shaft.
INDUSTRIAL GRADE ENGINEERED NYLON	160°	220		Yes	Grain, Feed, Fertilizer	Economical replacement for wood.
WHITE MELAMINE	190°	220	Yes		Food	Suitable for repeat use in food contact applications at temps not exceeding 190°F.
FOOD GRADE ENGINEERED NYLON	300°	220	Yes	Yes	Food, Grain, Fertilizer	For dry application.
BALL BEARING	180°	60, 70			Non-abrasive applications	General purpose use.
<i>Martin</i> HDPE	200°	220	Yes	Yes	Grain, Feed, Chemical Handling	Recommended for non-abrasive applications
CERAMIC ¹	1,000°	220, 216	Yes		Chemical, Cement, Food	Requires hardened shafts.
<i>Martin</i> URETHANE	200°	220		YES	Grain, Chemical, Fertilizer	Good general purpose.

¹ Higher temperature ceramics are available.

Hanger Bearings

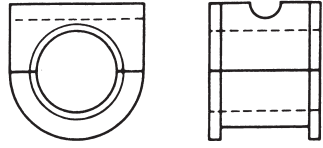

Hanger Types	Shaft Diameter	Part Number	Bearing
216 230 316	1 1/2	CHB2163*	
	2	CHB2164*	
	2 7/16	CHB2165*	
	3	CHB2166*	
	3 7/16	CHB2167*	

*H — Hard Iron *W — Wood *BR — Bronze *U — UHMW *G — Gatke *ER — Ertalyte® *C — Ceramic *ST — Stellite *UR — Urethane

*Oil hole is furnished on hard iron and bronze standard.

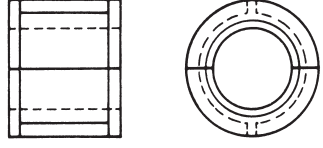
Hanger Types	Shaft Diameter	Part Number	Bearing
220 226 326 30	1	CHB2202*	
	1 1/2	CHB2203*	
	2	CHB2204*	
	2 7/16	CHB2205*	
	3	CHB2206*	
	3 7/16	CHB2207*	

*H — Cast Hard Iron with oil hole *W — Wood *N — Nylatron *P — HDPE *G — Gatke *ER — Ertalyte®
 *MHI — *Martin* Hard iron (oil impregnated) *MCB — Melamine (Furnished Less Flanges) *C — Ceramic *WN — White Nylon *WI — White Iron
 *MBR — *Martin* Bronze (oil impregnated) *U — UHMW *UR — Urethane

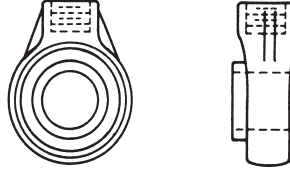
Hanger Types	Shaft Diameter	Part Number	Bearing
60 Ball Bearing 70 Ball Bearing	1 1/2	CHB603	
	2	CHB604	
	2 7/16	CHB605	
	3	CHB606	
	3 7/16	CHB607	

Note: New style bearings are available with slinger shield one side.

Hanger Types	Shaft Diameter	Part Number	Bearing
18B 19B	1 1/2	CHB18B3*	
	2	CHB18B4*	
	2 7/16	CHB18B5*	
	3	CHB18B6*	
	3 7/16	CHB18B7*	

*W — Wood *H — Hard Iron *N — Nylatron *G — Gatke

Note: Furnished as bottom cap only.

Ertalyte® is Registered Trademarks of Quadrant Engineered Plastic Products.

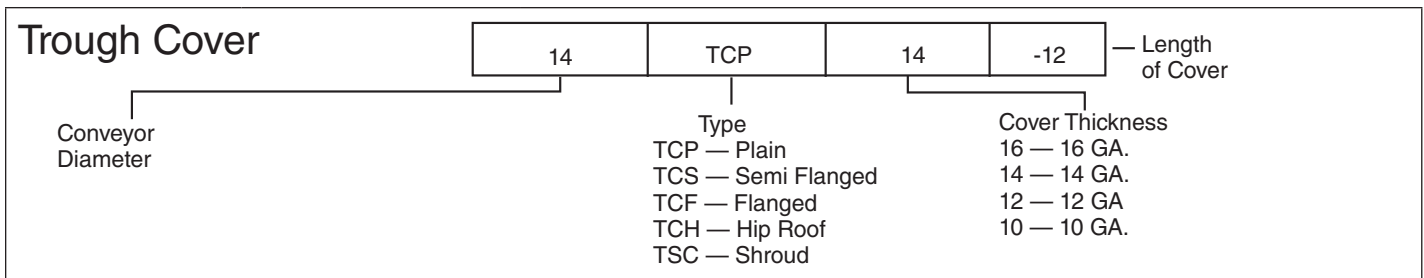

It is the responsibility of the contractor, installer, owner and user to install, maintain and operate the conveyor components and conveyor assemblies manufactured and supplied by *Martin* in such a manner as to comply with the Williams-Steiger Occupational Safety and Health Act and with all state and local laws and ordinances and the American National Standard Institute Safety Code.

FLANGED COVERS		Most commonly used. Can be supplied with gaskets and butt straps for dust tight applications. Semi-flanged must be furnished if spring clamps are used.
FLAT COVERS		Usually used only to cover conveyor for safety.
FLARED TROUGH COVERS		Usually flanged type and heavier gauges because of span.
HIP ROOF COVERS		Hip roof covers are similar to conventional flanged covers except they are peaked slightly to form a ridge along the center of the cover. A welded end plate closes the peaked section at each end of the trough while intermediate joints are usually buttstrap connected. Hip roof covers are usually recommended for outdoor installations to prevent accumulation of moisture. They are also often used in applications where a more rigid cover is required.
SHROUD COVERS		Used to approximate tubular cross section for inclined or feeder applications.
DOMED COVERS		Domed covers are half circle domes rolled to the same inside diameter as the trough bottom and are flanged for bolting to the trough top rails. They are used where venting of fumes or heat from the material being conveyed is required. End sections have a welded end plate and intermediate joints are buttstrap connected. Vent pipes or suction lines can be attached to the cover.
FEEDER SHROUDS		Shrouds are used in trough sections of screw feeders to decrease the clearance between the cover and feeder screw to obtain proper feed regulation. Lengths are sufficient to prevent flushing of the majority of materials being handled and gauges are proportioned to trough size and gauge.

Trough Covers



<p>Plain Cover</p>	<p>All conveyor troughs should have some type of cover not only to keep material inside the trough and to protect material in the trough from outside elements, but trough definitely should be covered as a safety measure, preventing injuries by keeping workers clear of the moving parts inside the conveyor trough. See H-122, Safety.</p>
<p>Semi-flanged Cover</p>	
<p>Flanged Cover</p>	
<p>Hip Roof Cover</p>	

Conveyor Diameter	Plain Cover				Plain Semi-Flanged Cover				Flanged Cover				Hip Roof Cover			
	Part Number	Thickness Ga.	Wt. per ft.	D	Part Number	Thickness Ga.	Wt. per ft.	D	Part Number	Thickness Ga.	Wt. per ft.	D	Part Number	Thickness Ga.	Wt. per ft.	D
4	4TCP16	16	1.5	8	4TCS16	□ 16	2.1	8 1/8	4TCF16	□ 16	1.9	8 3/8	4TCH16	□ 16	2	
*					4TCS14	14	2.6		4TCF14	14	2.4		4TCH14	14	2.5	8 3/8
6	6TCP16	16	2	9 3/4	6TCS16	□ 16	2.3	10 1/8	6TCF16	□ 16	2.1	10 3/8	6TCH16	□ 16	2.3	10 3/8
*					6TCS14	14	3.8		6TCF14	14	2.6		6TCH14	14	2.8	
9	9TCP14	14	3.5	13 3/8	9TCS14	□ 14	4.1	13 3/4	9TCF16	16	3.2	14	9TCH16	16	3.3	14
					9TCS12	12	5.7		9TCF14	□ 14	3.9		9TCH14	□ 14	4.1	
					9TCS10	10	7.3		9TCF12	12	5.5					
*									9TCF10	10	7.1					
10	10TCP14	14	3.8	14 3/8	10TCS14	□ 14	4.4	14 3/4	10TCF16	16	3.4	15	10TCH16	16	3.5	15
					10TCS12	12	6.1		10TCF14	□ 14	4.2		10TCH14	□ 14	4.3	
					10TCS10	10	7.8		10TCF12	12	5.9					
*									10TCF10	10	7.6					
12	12TCP14	14	4.6	17 1/2	12TCS14	□ 14	5.1	17 1/2	12TCF14	□ 14	4.9	18	12TCH14	□ 14	5	18
					12TCS12	12	7.1		12TCF12	12	6.9		12TCH12	12	7.1	
**					12TCS10	10	9		12TCF10	10	8.8					
14	14TCP14	14	5.1	19 1/2	14TCS14	□ 14	5.6	19 1/2	14TCF14	□ 14	5.4	19 7/8	14TCH14	□ 14	5.5	19 7/8
					14TCS12	12	7.8		14TCF12	12	7.6		14TCH12	12	7.7	
**					14TCS10	10	9.9		14TCF10	10	9.7					
16	16TCP14	14	5.6	21 1/2	16TCS14	□ 14	6.1	21 1/2	16TCF14	□ 14	5.9	21 7/8	16TCH14	□ 14	6.1	21 7/8
					16TCS12	12	8.5		16TCF12	12	8.3		16TCH12	12	8.5	
**					16TCS10	10	10.8		16TCF10	10	10.6					
18	18TCP12	12	8.9	24 1/2	18TCS12	□ 12	9.6	24 1/2	18TCF14	14	6.7	25	18TCH14	14	6.8	25
					18TCS10	10	12.3		18TCF12	□ 12	9.4		18TCH12	□ 12	9.5	
**									18TCF10	10	12.1					
20	20TCP12	12	9.7	26 1/2	20TCS12	□ 12	10.3	26 1/2	20TCF14	14	7.2	27	20TCH14	14	7.4	27
					20TCS10	10	13.3		20TCF12	□ 12	10.1		20TCH12	□ 12	10.4	
**									20TCF10	10	13.1					
24	24TCP12	12	11.1	30 1/2	24TCS12	□ 12	11.8	30 1/2	24TCF14	14	8.3	31	24TCH14	14	8.4	31
					24TCS10	10	15.1		24TCF12	□ 12	11.6		24TCH12	□ 12	11.8	
**									24TCF10	10	14.9					

For average applications where dust confinement is not a problem, 2'-0" centers or 10 fasteners per 10'-0" section are generally satisfactory. For commercially dust tight 1'-0" centers or 20 fasteners per 10'-0" section are suggested.

*L — Standard lengths are 5'-0" & 10'-0"

**L — Standard lengths are 5', 6', 10' & 12'-0"

□ — Standard gauge

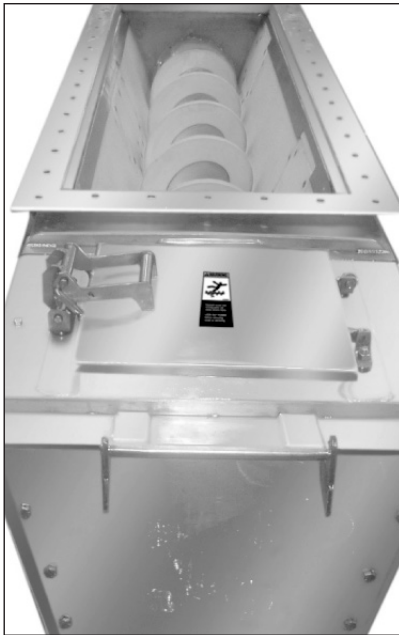

The *Martin* dust tight inspection door is ideal for visual inspection in dusty applications. Once installed, the *Martin* inspection door will give you years of trouble free service. It allows efficient access by authorized personnel while maintaining security with a latch that can be bolted or locked. The door comes with a poured black rubber door seal for chemical resistance and long life. The hinge and latch on all models are laser cut of 304 SS material for precision and corrosion resistance.

- Moisture and Dust Tight
- Heavy-Duty Construction
- Installs Easily on Existing Equipment
- Simple Operation
- Stocked in Carbon Steel and 304SS
- 316SS Available upon request

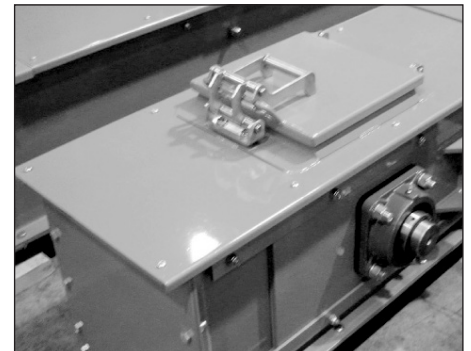
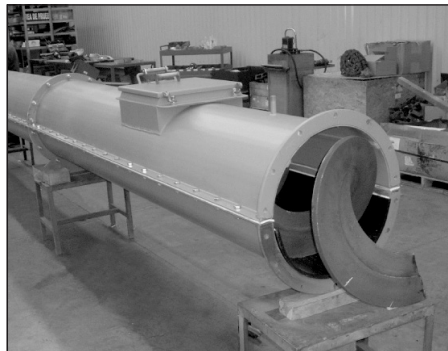

The *Martin* dust tight inspection door can be supplied with an expanded metal screen welded inside the opening to prevent physical access to moving parts. These doors are available from stock in many sizes. Custom sizes can be manufactured to fit your specific needs.

Call your local *Martin* Distributor for more information.

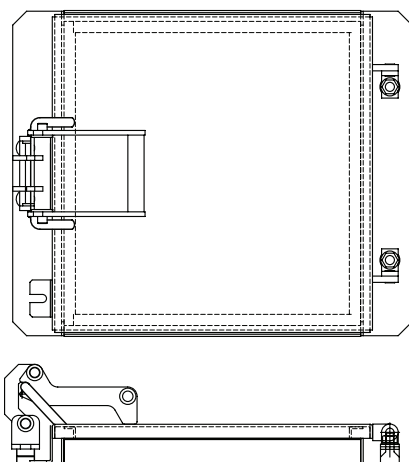

MDT[®] *Martin* Dust Tight Doors

Part Number		Size
Carbon Steel*	Stainless Steel	
0606PG-ID	0606PG-ID-SS	6" × 6"
0909PG-ID	0909PG-ID-SS	9" × 9"
1010PG-ID	1010PG-ID-SS	10" × 10"
1212PG-ID	1212PG-ID-SS	12" × 12"
1414PG-ID	1414PG-ID-SS	14" × 14"
1616PG-ID	1616PG-ID-SS	16" × 16"

*Carbon Steel construction with Stainless Steel Hinge.

Martin Dust Tight Doors are stocked in Carbon Steel and 304SS, 316SS is available upon request. Special sizes also available upon request.

Cover Accessories



Flanged Conveyor Inlets

The two styles of flanged conveyor inlets are designed for either bolting or welding to flat or flanged conveyor trough cover. The inlet size and bolt arrangement is the same as the standard conveyor discharge spout.

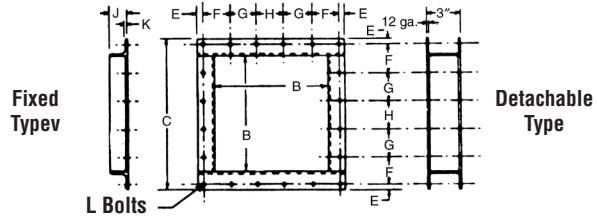

Conveyor Diameter	Part Number		Weight	B	C		E		F	G	H	J	K	L
	Fixed Inlet	Detachable Inlet			Fixed Inlet	Detachable Inlet	Fixed Inlet	Detachable Inlet						
4	4CIF	4CID	1.8	5	7 1/2	7 1/2	3/8	3/8	2 1/4	—	2 1/4	1 1/4	3/16	1/4
6	6CIF	6CID	5.0	7	10	10	11/16	11/16	2 13/16	—	3	1 1/2	3/16	3/8
9	9CIF	9CID	6.8	10	13	13	1/2	1/2	4	—	4	1 1/2	3/16	3/8
10	10CIF	10CID	7.4	11	14 1/4	14 1/4	5/8	5/8	4 5/16	—	4 3/8	1 1/2	3/16	3/8
12	12CIF	12CID	12.1	13	17 1/4	17 1/4	3/4	7/8	5 1/8	—	5 1/4	2 1/8	3/16	3/8
14	14CIF	14CID	13.7	15	19 1/4	19 1/4	3/4	7/8	3 1/2	3 1/2	3 1/2	2 1/8	3/16	3/8
16	16CIF	16CID	15.8	17	21 1/4	21 1/4	3/4	7/8	3 3/4	4	4	2 1/8	3/16	3/8
18	18CIF	18CID	29.0	19	24 1/4	24 1/4	1	1 1/8	4 7/16	4 3/8	4 3/8	2 1/2	3/16	1/2
20	20CIF	20CID	31.8	21	26 1/4	26 1/4	1	1 1/8	4 7/8	4 3/4	4 3/4	2 1/2	3/16	1/2
24	24CIF	24CID	37.2	25	30 1/4	30 1/4	1	1 1/8	5 5/8	5 5/8	5 1/2	2 1/2	3/16	1/2

Spring Clamps

Spring Clamps are used to attach plain and semi-flanged covers to trough. These clamps are normally riveted to the trough flange and will pivot to allow removal of cover.

Clamp No.	A	B	C	D	E	F	G	H	J	Wt.
SPC-1	5/16	3/16	5/16	2	1 1/4	1 5/16	3	7/8	9/32	.38

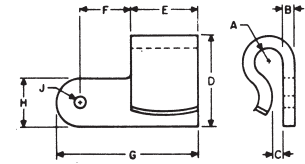

Spring Clamps with Cover Bracket

Spring Clamps with cover brackets are designed to attach to the top side of semi-flanged and plain covers.

Clamp No.	A	B	C	D	E	F	G	H	J	Wt.
SPCA-1	11/16	1/2	3/16	1 1/2	1 9/16	3/8	7/8	3/8	1 1/4	.50

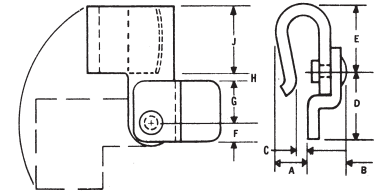

Screw Clamps

Screw Clamps are a simple and effective means of attaching flanged or flat covers to trough. Screw Clamps available in mild steel, stainless steel and zinc plated.

Clamp No.	A	B	C	D	E	F	G	J	Wt.
CSC-2	2 1/4	1	1 3/16	1 7/16	5/16	3/8	1/2	.42	.50

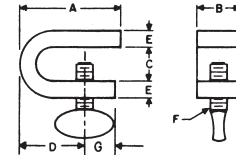

Cover Gaskets

Conveyor Diameter	Size		
	Red Rubber	Sponge Rubber	*White Rubber
4.6	RR125 1/8 x 1 1/4	SP125 1 1/8 x 1 1/4	WN125 1/8 x 1 1/4
9,10	RR150 1/8 x 1 1/2	SP150 1/8 x 1 1/2	WN150 1/8 x 1 1/2
12, 14, 16	RR200 1/8 x 2	SP200 1/8 x 2	WN200 1/8 x 2
18, 20, 24	RR250 1/8 x 2 1/2	SP250 1/8 x 2 1/2	WN250 1/8 x 2 1/2

Toggle Clamps

Quick acting toggle clamps are used to attach covers for quick accessibility. Normally this type clamp is attached by welding the front or top of clamp to the trough and can be adjusted to fit all sizes of trough, while allowing 90° to clear working area.

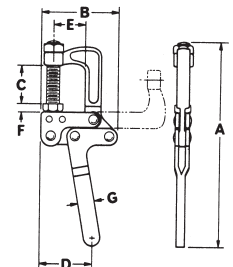

Conveyor	Part Number	No. Required per 10' Section	A	B	C	D	E	F	G
4 - 24	QTC	6 to 8	7 13/16	2 15/16	1 25/32	2	1 1/4	5/16	5/8

Feeder Shrouds

Shrouds are used in trough sections of screw feeders to decrease the clearance between the cover and feeder screw to obtain proper feed regulation. Lengths are sufficient to prevent flushing of the majority of materials being handled and gauges are proportioned to trough size and gauge.

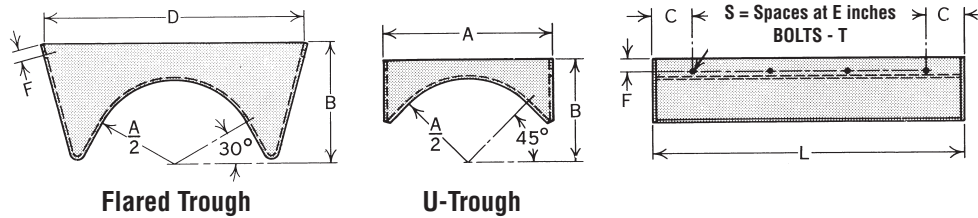

Screw Diameter	Part Number		Shroud Thickness	A	B		C	D	E	F		L	T	S
	U	Flared			U	Flared				U	Flared			
4	4TFS14	4FFS14	14 Ga.	5	3 5/8	—	2	—	4	5/8	—	8	1/4	1
6	6TFS14	6FFS14	14 Ga.	7	4 1/2	7	3	14	6	3/4	3/4	12	5/16	1
	6TFS12	6FFS12	12 Ga.	7	4 1/2	7	3	14	6	3/4	3/4	12	5/16	1
9	9TFS14	9FFS14	14 Ga.	10	6 1/8	9	3	18	6	7/8	3/4	18	3/8	2
	9TFS7	9FFS7	3/16"	10	6 1/8	9	3	18	6	7/8	3/4	18	3/8	2
10	10TFS14	10FFS14	14 Ga.	11	6 3/8	—	2 1/2	—	5	7/8	—	20	3/8	3
	10TFS7	10FFS7	3/16"	11	6 3/8	—	2 1/2	—	5	7/8	—	20	3/8	3
12	12TFS12	12FFS12	12 Ga.	13	7 3/4	10	3	22	6	1 1/8	1	24	3/8	3
	12TFS7	12FFS7	3/16"	13	7 3/4	10	3	22	6	1 1/8	1	24	3/8	3
14	14TFS12	14FFS12	12 Ga.	15	9 1/4	11	3 1/2	24	7	1 1/8	1	28	3/8	3
	14TFS7	14FFS7	3/16"	15	9 1/4	11	3 1/2	24	7	1 1/8	1	28	3/8	3
16	16TFS12	16FFS12	12 Ga.	17	10 5/8	11 1/2	4	28	8	1 1/8	1	32	3/8	3
	16TFS7	16FFS7	3/16"	17	10 5/8	11 1/2	4	28	8	1 1/8	1	32	3/8	3
18	18TFS12	18FFS12	12 Ga.	19	12 1/8	12 1/8	4 1/2	31	9	1 3/8	1 3/8	36	3/8	3
	18TFS7	18FFS7	3/16"	19	12 1/8	12 1/8	4 1/2	31	9	1 3/8	1 1/8	36	3/8	3
20	20TFS10	20FFS10	10 Ga.	21	13 1/2	13 1/2	4	34	8	1 3/8	1 3/8	40	3/8	4
	20TFS7	20FFS7	3/16"	21	13 1/2	13 1/2	4	34	8	1 3/8	1 3/8	40	3/8	4
24	24TFS10	24FFS10	10 Ga.	25	16 1/2	16 1/2	4	40	8	1 3/8	1 3/8	48	3/8	5
	24TFS7	24FFS7	3/16"	25	16 1/2	16 1/2	4	40	8	1 3/8	1 3/8	48	3/8	5

Conveyor Shrouds

Conveyor shroud covers are used to form a tubular cross section within the conveyor trough. This arrangement gives the features of a tubular housing while allowing removal of the shroud for easy access and cleaning. Flat or flanged covers can be used over the shroud cover when it is objectionable for the recess in the shroud to be exposed to dust or weather. Various types of shrouds are furnished to fit various applications. These types are described below.

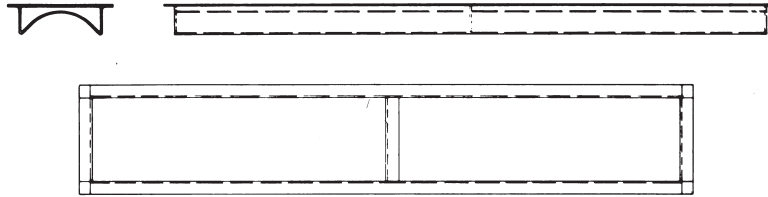

Type 1

Type 1 Shroud cover has flanged sides over top rail and flanged ends at both ends. This type is used when shroud is full length of trough or between hangers.

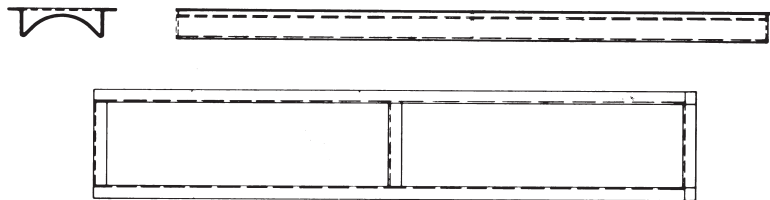

Type 2

Type 2 Shroud cover has flanged sides over top rails and flanged ends on one end over trough end; other end is plain. This type shroud is used at an inlet opening or next to a hanger at the plain end.

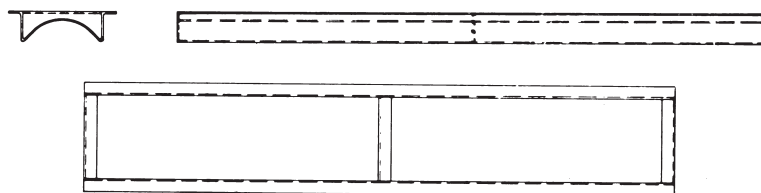

Type 3

Type 3 Shroud cover has flanged sides over top rail and both ends closed and no flanges over ends. This type shroud is used between hangers.

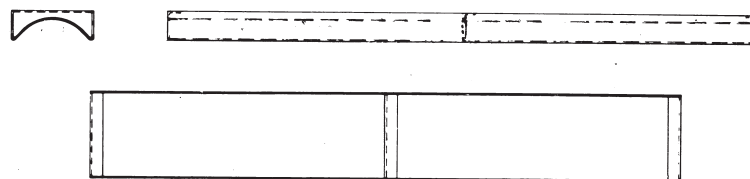

Type 4

Type 4 Shroud cover has no flanges at sides or ends. Bolt holes are provided along sides, for bolting through side of trough. This allows flush mounting with top of trough and a cover may be used over the shroud. This shroud is used mostly for short lengths when installed ahead of an inlet opening.

SPECIAL FEATURES	PAGE
COVERS.....	H-108
TROUGH ENDS	H-109
TROUGH	H-110
CONVEYOR SCREWS.....	H-113
DISCHARGES.....	H-118
INLET	H-119

Special Features

The information presented in this section gives descriptions and functions of the most commonly used special features available in the design of conveyor systems.

These special features will greatly broaden the range of uses for screw conveyor when added to the many standard features available. Standard features and components are always more desirable and practical in the design of a screw conveyor system; however, one or more of these special features may sometimes be required in special applications for a workable or more efficient system.

	<p>OVERFLOW COVER sections are used as a safety relief to handle overflow over the discharge in cases where the discharge may become plugged. It is a short section of flanged or flat cover hinged across the width to the adjoining cover. The cover is not attached to the trough in order that it can be raised by pressure from within the trough.</p>
	<p>SHROUD COVERS are designed to fit inside a standard conveyor trough of a Screw Feeder or inclined conveyor, and create a tubular trough effect. This cover has an advantage over tubular trough in that ease of access is combined with the convenience of using standard hangers and accessories. An additional flat cover may be required over the shroud to prevent accumulation of dust or water in the recessed portion of the shroud cover.</p>
	<p>EXPANDED METAL COVERS can be furnished where cover is required for safety but constant visual inspection is required.</p> <p>STANDARD COVERS of any design can be furnished in heavier gauges, when needed to support weight.</p>
	<p>DOMES COVERS are half circle domes rolled to the same inside diameter as the trough bottom and are flanged for bolting to the trough top rails. They are used where venting of fumes or heat from the material being conveyed is required. End sections have a welded end plate and intermediate joints are buttstrap connected. Vent pipes or suction lines can be attached to the cover.</p>
	<p>DUST SEAL COVERS are flanged down on all four sides to match channel sections fabricated on the sides, ends, and cross channels of special dust seal troughs. The length of the cover should not exceed one-half the length of the trough section.</p>
	<p>HINGED COVERS may be constructed from conventional flat covers or most special covers. They are equipped with a hinge on one side for attaching to the trough and are bolted or clamped to the trough on the other side. Hinged covers are used in applications where it is not desirable to have a loose cover, such as in high areas above walkways where the cover might fall.</p>
	<p>HIP ROOF COVERS are similar to conventional flanged covers except they are peaked slightly to form a ridge along the center of the cover. A welded end plate closes the peaked section at each end of the trough while intermediate joints are usually buttstrap connected. Hip roof covers are usually recommended for outdoor installations to prevent accumulation of moisture. They are also often used in applications where a more rigid cover is required.</p>

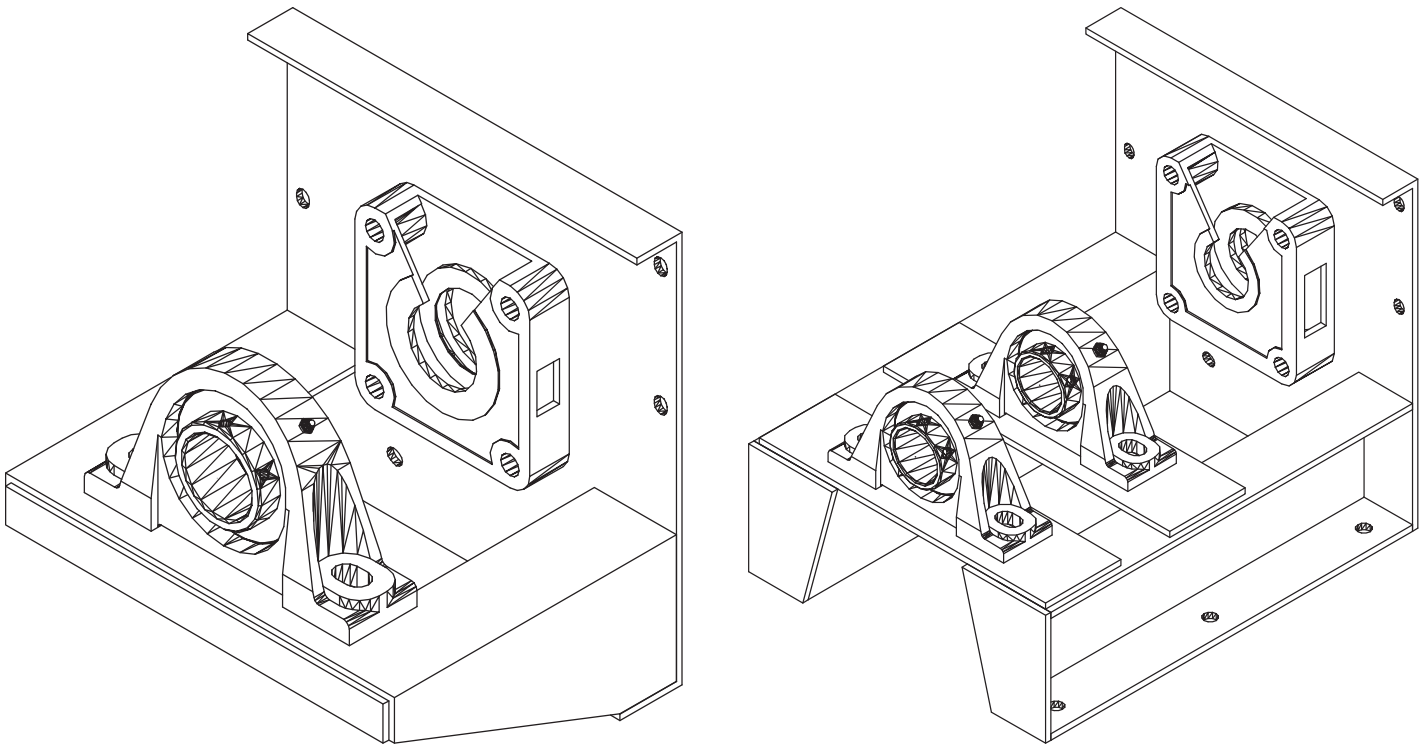

SHELF-TYPE TROUGH ENDS are furnished with outboard bearing pedestals for mounting pillow block bearings. The bearings are mounted away from the trough end plate allowing ample room to protect the bearing when handling abrasive or hot materials. This arrangement allows the use of most any type shaft seal desired. Either one or two bearings can be used.

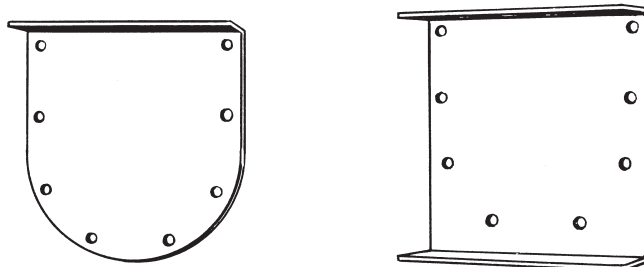

BLIND TROUGH ENDS are used on the tail end (normally the inlet end) of a conveyor, when sealing the end shaft is extremely difficult. A hanger is used inside the trough to support the tail shaft without the shaft projecting through the trough end.

A blind trough end plate can also be furnished with a dead shaft welded to the end plate. For this type the screw is bushed with an antifricition bearing to carry the radial load of the screw. When required, a grease fitting can be furnished through the dead shaft for lubricating the bearing.

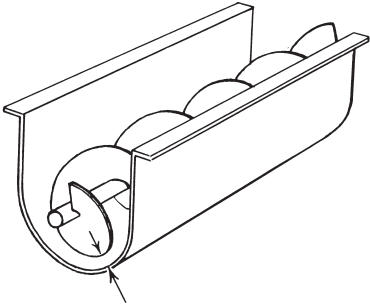
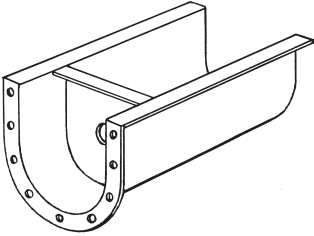
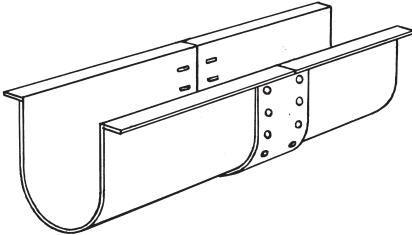
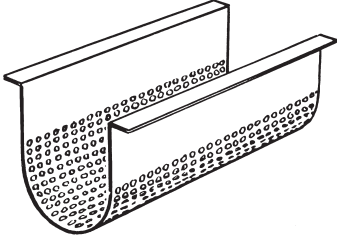
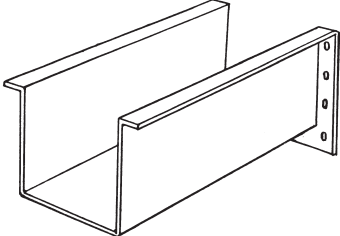
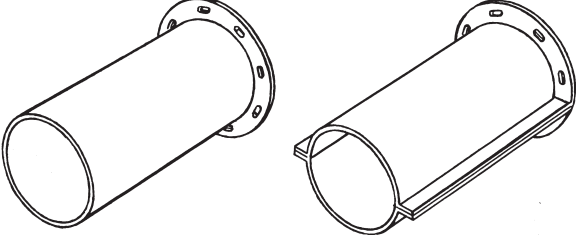
	<p>WIDE CLEARANCE TROUGH is of conventional construction except with a wider clearance between the outside of the conveyor screw and the inside of the trough. This type trough is used when it is desirable to form a layer of conveyed material in the trough. The material thus moves on itself, protecting the trough from undue wear. By using a wide clearance or oversize trough, a greater capacity than using a standard conveyor screw can be obtained for some materials that travel as a mass. When wide clearance trough is required, it is more economical to use a standard conveyor screw and the next larger size standard trough.</p>
	<p>BULK HEAD is a plate or baffle shaped to the contour of the inside of the trough and is normally welded or bolted six to twelve inches from the trough end. The bulk head protects the end bearing and drive unit from heat while handling hot materials, when the pocket formed is filled with packing or insulation. The bulk head can be used in the same manner to prevent damage to seals and bearings when handling extremely abrasive materials.</p>
	<p>EXPANSION JOINT is a connection within a length of trough to allow for expansion caused by hot materials being conveyed. The expansion joint is constructed with bolts fastened in slots to allow for expansion or with a telescoping type slip joint. The number of joints and amount of expansion will depend on the application.</p>
	<p>PERFORATED BOTTOM TROUGH is equipped with a perforated bottom, and is used as a screening operation or drain section when liquids are present in the conveyed material. The size of the perforations in the trough will vary depending on the material and application.</p>
	<p>RECTANGULAR TROUGH is made with a flat bottom and can be formed from a single sheet or with sides and bottom of separate pieces. This type trough is frequently used in handling abrasive materials capable of forming a layer of material on the bottom of the trough. The material thus moves on itself, protecting the trough from undue wear. Also in handling hot materials, the material will form its own internal insulation with this type trough.</p>
	<p>TUBULAR TROUGH is furnished in either solid tube construction or split tube construction with flanges for bolting or clamping the two halves together. This trough is a complete tube enclosure and is used for weather-tight applications, for loading to full cross sections, and for inclined or vertical applications where fall back necessitates the housing to operate at a full loading.</p>

*Conveyors shown without cover for illustration purposes only. Please follow manufacturing safety guidelines when operating conveyors.

<p style="text-align: center;">Close</p>	<p>CLOSE CLEARANCE TROUGH is of conventional construction except with a closer clearance between the outside of the conveyor screw and the inside of the trough. This type trough leaves less material in the trough and is often used when a greater clean-out of conveyed material is required. This type trough also minimizes fall back of certain materials in an inclined conveyor.</p>
	<p>DROP BOTTOM TROUGH is equipped with either a bolted or clamped and completely removable drop bottom, or hinged on one side with bolts or clamps on the opposite side. This design offers ease in cleaning of the trough and screw conveyor, and is often used when handling food products where internal inspection and cleaning of the screw conveyor is necessary.</p>
	<p>DUST SEAL TROUGH (Sometimes referred to as SAND SEAL TROUGH) has Z-bar top flanges and formed channel cross members making a continuous channel pocket around the top of the trough into which a special flanged cover is set. The channel is filled with sand or dust of the product being conveyed, thus creating an effective seal against the escape of dust from within the conveyor.</p>
	<p>CHANNEL SIDE TROUGH is made with separate detachable trough bottoms, bolted or clamped to formed or rolled steel channels. The channels may be of any reasonable length to span widely spaced supports. This type of trough is occasionally used for easy replacement of trough bottoms, and to facilitate repairs when conveyor screw and hangers are not accessible from the top. The channel side trough can also be used without a bottom for filling bins and hoppers.</p>
	<p>HIGH SIDE TROUGH is of conventional construction except that the trough sides extend higher than standard from the center line to the top of the trough. This type trough is frequently used in conveying materials which mat together and travel as a mass on top of the conveyor screw. High side trough will confine this type material in the trough, but still affords the necessary expansion room.</p>
	<p>JACKETED TROUGH consists of a formed jacket continuously welded to the trough. This type trough is widely used for heating, drying or cooling of materials. Pipe connections are provided for supply and discharge of the heating or cooling media. Special construction must be provided for higher pressures.</p>

*Conveyors shown without cover for illustration purposes only. Please follow manufacturing safety guidelines when operating conveyors.

	<p>HOLD DOWN ANGLES are used to hold the conveyor screw in the trough when the conveyor is operated without intermediate hangers or when chunks of material may tend to ride under the conveyor screw and push it up. The angle is constructed of formed or regular angle iron and is attached to one side of the full length of trough far enough above the conveyor screw to allow approximately one-half inch clearance between the bottom angle and the conveyor screw.</p>
	<p>INSULATED CONVEYOR TROUGH is used when handling hot or cold materials. There are many types of insulation materials and arrangements that can be used.</p>
	<p>RIDER BARS are flat bars one to one and one-half inches in width running part of length or full length of the trough. Two or four bars are normally used and are spaced an equal distance apart along the curved bottom of the trough. The bars are used to support the conveyor screw to prevent wear on the trough when internal hanger bearings are not used. Rider bars are sometimes referred to as Rifling Bars when they are used to assist in conveying materials that tend to stick to the conveyor screw and rotate with it.</p>
	<p>SADDLE TYPE WEAR PLATES are plates curved to the contour of the inside of the trough and of slightly less thickness than the clearance between the conveyor screw and trough. The plates are made in lengths of approximately one and one-half times the pitch of the conveyor screw and are normally spaced at intervals equal to the distance between hangers. They are used to support the conveyor screw to prevent damage to the trough when internal hanger bearings are not used.</p>
	<p>STRIKE OFF PLATE (SHROUD BAFFLE) is a single plate bolted vertically to the upper portion of the trough and is cut out to the contour of the screw. This plate is used to regulate the flow of material from an inlet by preventing flooding across the top of the conveyor screw.</p>

*Conveyors shown without cover for illustration purposes only. Please follow manufacturing safety guidelines when operating conveyors.

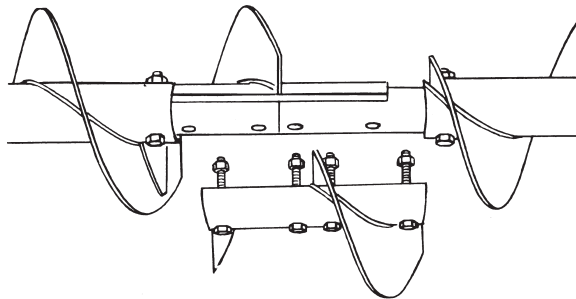

SPLIT FLIGHT COUPLINGS permit installation or removal of individual sections of conveyor screw without disturbing adjoining sections. When they are installed on both sides of each hanger, sections of screw can be removed without disturbing the hangers. These must be furnished complete with matching shafts.

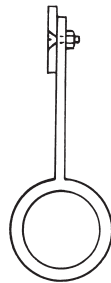

WEAR FLIGHTS, or wearing shoes, attached with countersunk bolts to the carrying side of conveyor screw flights are used for handling highly abrasive materials and are easily replaceable.



QUICK DETACHABLE KEY CONVEYOR SCREW is designed for easy removal from the conveyor trough. Each section of screw is provided with a removable key located at one end of the pipe. By removing this key, a conveyor screw section and coupling with a hanger can be quickly removed without disturbing other components.

Width of Application Chart

Screw Diameter	Standard Width of Application
6	1
9	1 1/2
12	2
14	2
16	2 1/2
18	2 1/2
20	3
24	3



Helicoid



Sectional

NOTE: Weld-on type normally 1/16" thick.

HARD SURFACED FLIGHTS sometimes called abrasive resistant conveyors can be furnished using one of many hardsurfacing processes. The hard surfaced area is normally an outer portion of the face of the flight on the carrying side of the conveyor screw. This process is applied to the conveyor screw to resist wear when handling highly abrasive materials.

Conveyor Screws

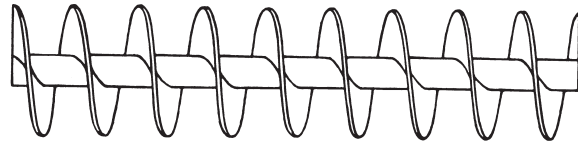

SHORT PITCH CONVEYOR SCREWS are of regular construction except that the pitch of the flights is reduced. They are recommended for use in inclined conveyors of 20 degrees slope and over, and are extensively used as feeder screws, and for controlling cross sectional loading in the balance of a conveyor when short pitch is used at the inlet opening.

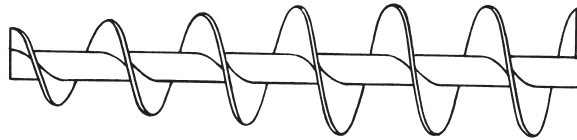

TAPERING FLIGHT CONVEYOR SCREWS are frequently used as feeder screws for handling friable lumpy material from bins or hoppers and also to draw the material uniformly from the entire length of the feed opening.

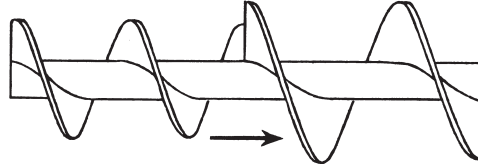

STEPPED DIAMETER CONVEYOR SCREWS consist of flights of different diameters, each with its regular pitch, mounted in tandem on one pipe or shaft. They are frequently used as feeder screws, with the smaller diameter located under bins or hoppers to regulate the flow of material.

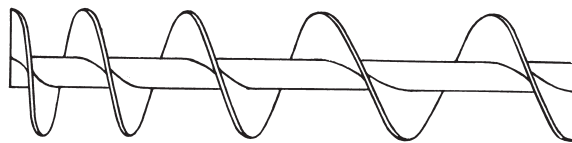

STEPPED PITCH CONVEYOR SCREWS are screws with succeeding single or groups of flights increasing in pitch and are used as feeder screws to draw free-flowing materials uniformly from the entire length of the feed opening.



CONE SCREW to withdraw material evenly from a hopper or bin. Constant pitch reduces bridging. Requires less start-up horsepower.
H-114

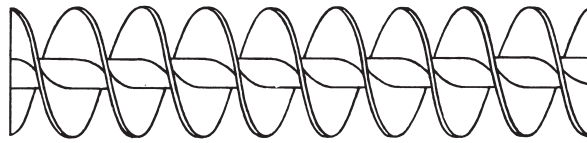

DOUBLE FLIGHT CONVEYOR SCREWS of regular pitch promote a smooth gentle flow and discharge of certain materials. Double flight can be used at hanger points only, for smooth flow past hangers.

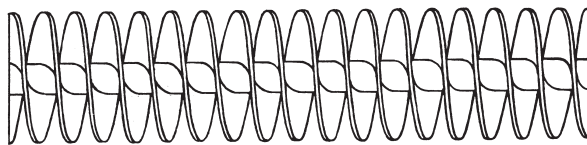

DOUBLE FLIGHT SHORT PITCH CONVEYOR SCREWS assure more accurate regulation of feed and flow in screw feeders and effectively deter flushing action of fluid materials.

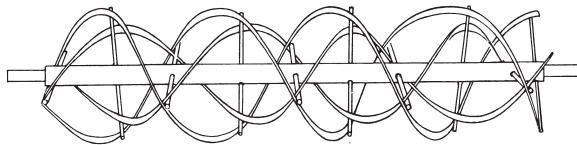

MULTIPLE RIBBON FLIGHT CONVEYOR SCREWS. This type of screw consists of two or more ribbon flights of different diameters and opposite hand, mounted one within the other on the same pipe or shaft by rigid supporting lugs. Material is moved forward by one flight and backward by the other, thereby inducing positive and thorough mixing. (Made per customer specifications.)

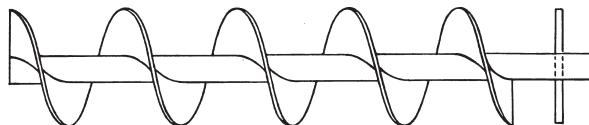

BREAKER PINS. The breaker pin is a rod approximately the same in length as the diameter of the conveyor screw and is inserted through the diameter of the pipe over the discharge to help break up lump materials.

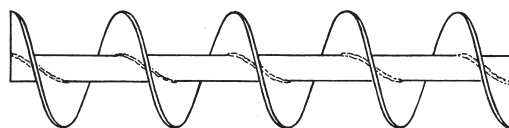

CONTINUOUS WELDING of the conveyor screw flight to the pipe can be furnished with welding one side or both sides. This welding is added to prevent stripping of flight from the pipe under extreme loads. The continuous welding can also be added to fill the slight crack between the flight and pipe for sanitary purposes.

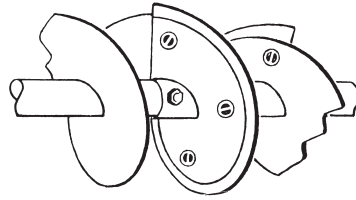

BEARING SHOES (Nylon, Teflon, Brass, and other bearing type materials.) Bearing shoes are used in place of internal bearings and are bolted to the conveyor screw. They are made from bearing type material, and when attached to the conveyor screw flight, the bearing shoe projects beyond the outer edge of flighting and rotates with the screw thereby preventing metal to metal contact between the conveyor screw and the trough. The bearing shoes extend around the helix slightly more than one pitch and are spaced along the screw at approximately the same intervals as internal bearings.

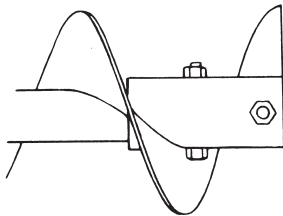

External Sleeves

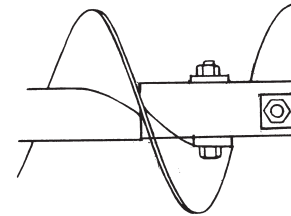

Bolt Pads

EXTERNAL SLEEVES OR BOLT PADS are added to the outside diameter of conveyor screw pipe at the end where the couplings are attached to reinforce the pipe at the bolt area.

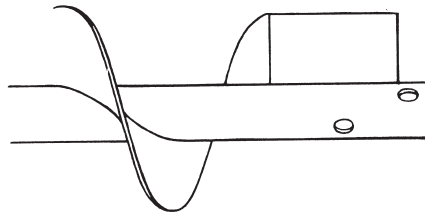

KICKER BARS are flat bars projecting from the conveyor screw pipe extending to the outside diameter of the screw over the discharge spout and are used to assist the discharge of materials.

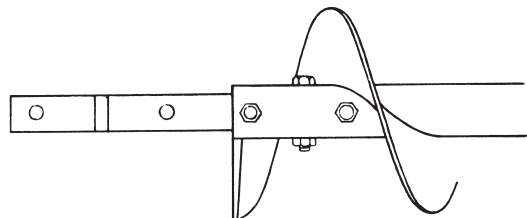

MULTIPLE HOLE DRILLING of the conveyor screw pipe and shafts will increase the torque rating of the bolted sections.

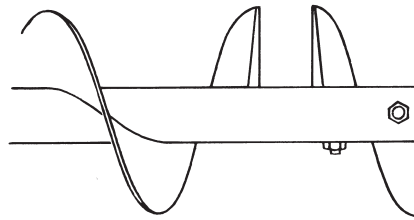

OPPOSITE HAND FLIGHTS are short sections (approximately one-half pitch) of flight added to the conveyor screw beyond the discharge point and are the opposite hand of the rest of the screw. This flight opposes the flow of material that tends to carry past the discharge spout and pack at the end plate and forces the material back to the spout for discharge.

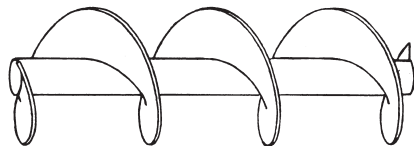

ODD DIAMETER CONVEYOR SCREW is of conventional construction except oversize or undersize in diameter. This type conveyor screw is used to provide a close clearance or wide clearance between the screw and trough and enable the use of standard component parts.

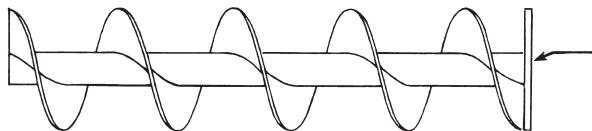

END DISC ON CONVEYOR SCREW. This disc is welded flush with the end of the conveyor screw pipe and is the same diameter as the screw. It rotates with the conveyor screw and assists in relieving the thrust of the conveyed material against the end plate shaft seal.

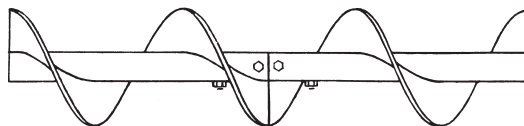

CLOSE COUPLED CONVEYOR SCREW. This type screw forms a continuous helix when two or more conveyor screws are close coupled by drilling the shaft of each to align the connecting flight.

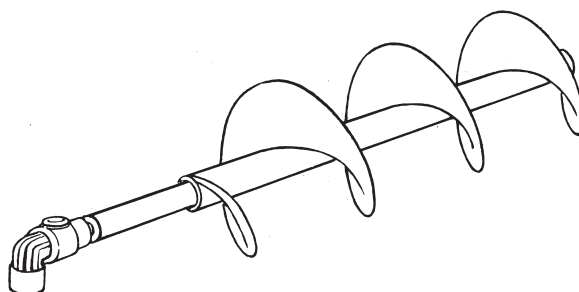

ROTARY JOINTS FOR COOLING AND HEATING are attached to one or both end shafts to provide a flow of heating or cooling media through the conveyor screw pipe.

Discharges

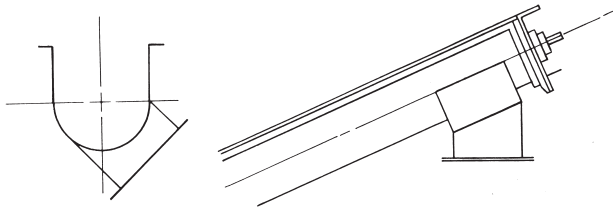

ANGULAR DISCHARGES can be furnished when necessary for certain applications. This type discharge is normally used on inclined conveyors when it is necessary that the discharge be parallel to ground level, or at other times when material must be discharged to one side.

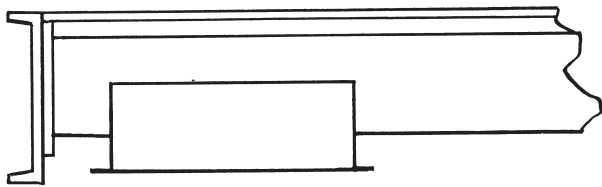

LONGER THAN STANDARD DISCHARGE SPOUTS are approximately one and one-half times the length of the standard discharge spouts. This discharge is used with materials hard to discharge due to the material trying to convey past the discharge opening. This discharge is also used when operating conveyors.

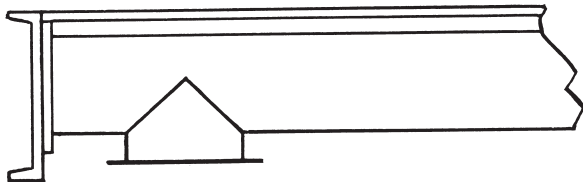

ROUND DISCHARGE SPOUTS are furnished where required for attaching tubular attachments, or when one conveyor discharges into another conveyor at an angle other than a right angle. By using a round discharge and round inlet the connection is easily made.

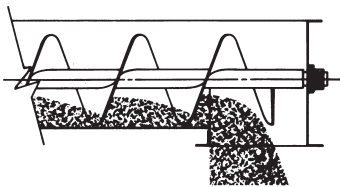

FLUSH END DISCHARGE SPOUTS are furnished with a special trough end plate constructed on trough end side of the spout. This type spout offers a complete discharge without a ledge at the end plate for material build up. It is used primarily in handling food products, where infestation may occur.

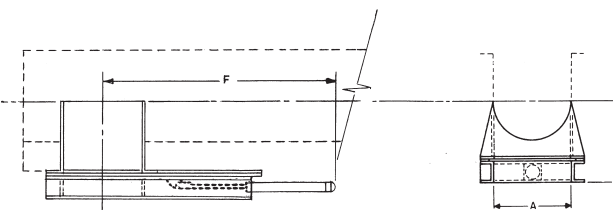

AIR OPERATED FLAT SLIDE GATES are similar in action and purpose to rack and pinion gates. The gate movement is accomplished by an air cylinder. These gates are usually employed when remote control and automatic operation is desired.

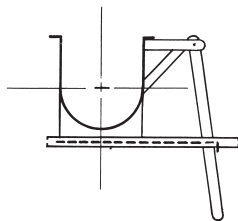

LEVER OPERATED GATES are a modification of standard slide discharges with a lever attached for opening and closing the gates. This attachment provides a leverage for ease of operation and a convenient means for quick opening and closing.

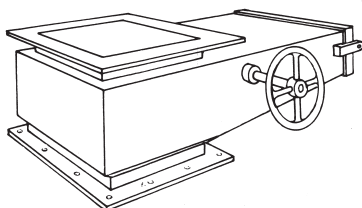

ENCLOSED DUST-TIGHT OR WEATHER-PROOF rack and pinion discharge spouts can be furnished in either flat or curved slide and are similar in construction to conventional rack and pinion slide gates except that the slide, rack, and pinion are fully enclosed in a housing.

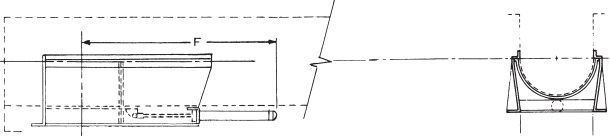
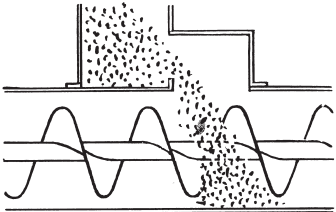
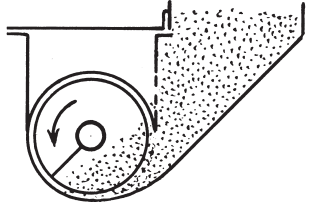
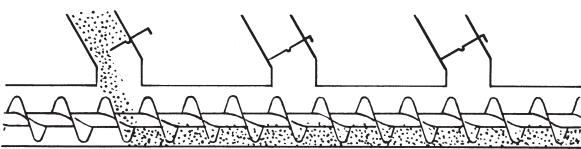
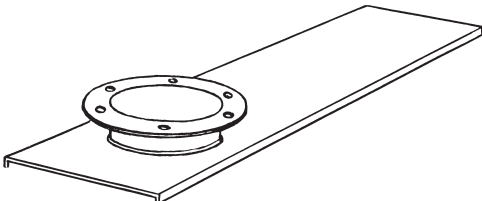
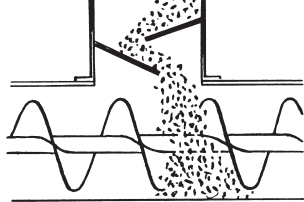
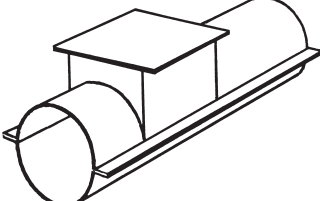
	<p>AIR OPERATED CURVED SLIDE GATES are similar to standard rack and pinion gates except they are operated with an air cylinder. The air operated gate is usually used for remote control and automatic operation. These gates can also be furnished in dust-tight or weather-proof construction with the cylinder and gate fully enclosed in the housing.</p>
	<p>CUSHION CHAMBER INLETS (DEAD BED INLETS) serve the same purpose as the deflector plate inlet, but are constructed with a ledge that forms a cushion for materials fed into the conveyor.</p>
	<p>SIDE INLETS are equipped with a gate to furnish a means of regulating or stopping the inlet flow to relieve the conveyor screw from excessive material pressures. When using the side inlet, the screw rotation should be toward the inlet opening to assure a constant flow rate.</p>
	<p>HAND SLIDE INLET GATES are normally used when multiple inlets are required. These inlets must be adjusted or closed manually to assure proper feed to the conveyor.</p>
	<p>ROUND INLET SPOUTS are used for tubular attachments or when connecting the discharge of one conveyor to the inlet of another at other than a right angle. This type connection is easily made with round discharges and inlets.</p>
	<p>DEFLECTOR PLATE INLETS are used when materials fall vertically into the inlet creating the possibility of impact damage or abrasion to the conveyor screw. The rectangular inlet is equipped with deflector plates, or baffles, that dampen the impact of the material in order to feed the conveyor more gently.</p>
	<p>HANGER POCKETS are used with tubular trough, mounted on top of the tubular trough at hanger bearing points. The hanger pocket forms a U-shape section for a short length, allowing the use of standard conveyor hangers and providing easy access to the hanger.</p>

Installation & Maintenance



INSTALLATION AND MAINTENANCE	PAGE
INSTALLATION AND ERECTION	H-120
OPERATION AND MAINTENANCE	H-121
HAZARDOUS OPERATIONS	H-121

General

All standard screw conveyor components are manufactured in conformity with Industry Standards. Special components are usually designed and manufactured to the particular job specifications.

Screw conveyors may be ordered either as complete units or by individual components. Complete units are normally shop assembled and then match marked and disassembled for shipment and field re-assembly. When components only are ordered, shipment is made as ordered, and these components must be sorted out and aligned in field assembly.

Because shop assembled screw conveyors are pre-aligned and match marked at the factory, they are easier to assemble in the field and require the minimum installation time. When individual components are ordered, more careful alignment and assembly are required. More time is required for field installation. Assembly bolts are not included with parts orders but are included with preassembled units.

Caution: All *Martin* Conveyors must be assembled and maintained in accordance with this section. Failure to follow these instructions may result in serious personal injury or property damage.

Installation

Receiving. Check all assemblies or parts with shipping papers and inspect for damage. Specifically check for dented or bent trough, bent flanges, bent flighting, bent pipe or hangers or damaged bearings. If any components are severely damaged in shipment, claims should be filed immediately with the carrier. NOTE: Handle Carefully! Fork lifts should have spreader bars to lift max. 24' lengths of assembled conveyors. Lift points should not exceed 10 - 12 feet.

Erection

For shop assembled conveyors, units are match marked and shipped in longest sections practical for shipment. Field assembly can be accomplished by connecting match marked joints, and in accordance with packing list, and/or drawing if applicable. In field erection, the mounting surfaces for supporting the conveyor must be level and true so there is no distortion in the conveyor. Shims or grout should be used when required. Check for straightness as assembly is made.

For conveyor assemblies purchased as parts or merchandise, assemble as follows: Place conveyor troughs in proper sequence with inlet and discharge spout properly located. Connect the trough flanges loosely. Do not tighten bolts. Align the trough bottom center-lines perfectly using piano wire (or equivalent) then tighten flange bolts. Tighten all anchor bolts.

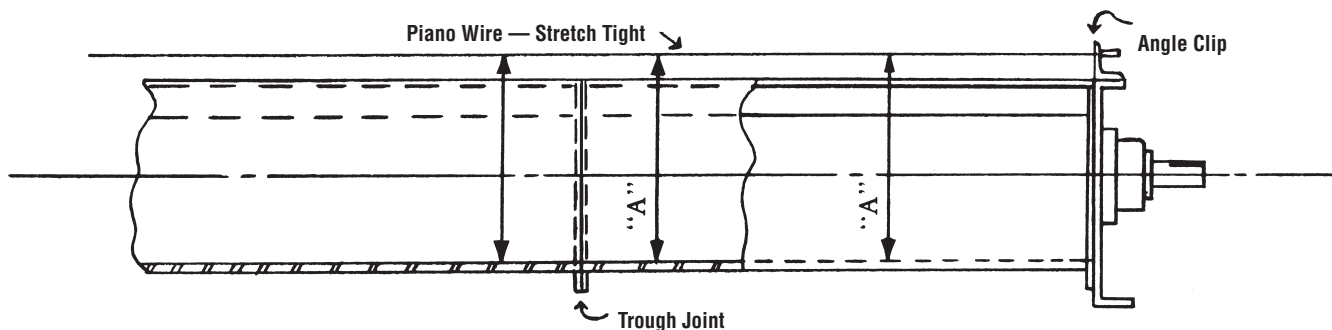

Assembly of conveyor screws should always begin at the thrust end. If the unit does not require a thrust unit, assembly should begin at the drive end. If a thrust end is designated, assemble trough end and thrust bearing. Insert the end, or drive shaft, in the end bearing. Do not tighten set screws until conveyor assembly is completed.

Place the first screw section in the trough, slipping the end, or drive shaft, into the pipe end. Secure tightly with coupling bolts. Install so that conveyor end lugs are opposite the carrying side of the flight.

Place a coupling shaft into the opposite end of conveyor pipe. Tighten coupling bolts.

Insert coupling shaft into hanger bearing and clamp hanger to trough.

Assemble alternately, conveyor screws, couplings and hangers until all screws are installed.

- 1) **With Hangers:** Assemble screw section so that flighting at each end is approximately 180° from ends of flighting of adjacent sections. Also, adjust conveyor screw and thrust unit so that hangers are equally spaced between adjacent screws.
- 2) **Without Hangers:** (close coupled) Assemble screws so that flighting at adjoining ends of screw sections align to produce a continuous helix surface. (Note coupling holes have been drilled in assembly to allow for flight alignment.)

Remove hanger clamps and bolt hanger to trough with the bearing centered between conveyor screws.

Install trough covers in proper sequence. Properly locate inlet openings. Handle covers with reasonable care to avoid warping or bending.

Attach covers to trough with fasteners provided.

Install drive at proper location and in accordance with separate instructions or drawing provided.

Check screw rotation for proper direction of material travel after electrical connections have been made but before attempting to handle material. Incorrect screw rotation can result in serious damage to the conveyor and to related conveying and drive equipment.

If necessary, reconnect electrical leads to reverse rotation of conveyor and direction of material flow.

Operation

Lubricate all bearings and drives per service instructions. Gear reducers are normally shipped without lubricant. Refer to service instructions for lubrication.

In start-up of the conveyor, operate several hours empty as a break in period. Observe for bearing heat up, unusual noises or drive misalignment. Should any of these occur, check the following and take necessary corrective steps. (Non-lubricated hanger bearings may cause some noise.)

- 1) When anti-friction bearings are used, check for proper lubrication. Insufficient or excess lubricant will cause high operating temperatures.
- 2) Misalignment of trough ends, screws, hangers and trough end can cause excessive maintenance and poor life expectancy.
- 3) Check assembly and mounting bolts; tighten if necessary.

Do not overload conveyor. Do not exceed conveyor speed, capacity, material density or rate of flow for which the conveyor and drive were designed.

If the conveyor is to be inoperative for a prolonged period of time, operate conveyor until cleared of all material. This is particularly important when the material conveyed tends to harden or become more viscous or sticky if allowed to stand for a period of time.

It may be necessary to recenter hanger bearings after running material in conveyor.

Maintenance

Practice good housekeeping. Keep the area around the conveyor and drive clean and free of obstacles to provide easy access and to avoid interference with the function of the conveyor and drive.

Establish routine periodic inspections of the entire conveyor to ensure continuous maximum operating performance.

To replace conveyor screw section, proceed as follows:

- 1) Removal of a section, or sections, usually must proceed from the end opposite the drive. Make sure drive and electrical power are disconnected before starting to disassemble.
- 2) Remove the trough end, sections of screws, coupling shafts and hangers until all sections have been removed or until the damaged or worn section is reached and removed.
- 3) To reassemble follow the above steps in reverse order.
- 4) Quick detachable conveyor screws can be removed at intermediate locations without first removing adjacent sections.

Replacement parts can be identified from a copy of the original packing list or invoice.

The coupling bolt contains a lock nut that may become damaged when removed. It is recommended practice to replace them rather than re-use them when changing conveyor screw sections.

Hazardous Operations

Screw conveyors are not normally manufactured or designed to operate handling hazardous materials or in a hazardous environment.

Hazardous materials can be those that are explosive, flammable, toxic or otherwise dangerous to personnel if they are not completely and thoroughly contained in the conveyor housing. Special construction of screw and conveyor housing with gaskets and special bolted covers can sometimes be used for handling this type of material.

Special conveyors are not made or designed to comply with local, state or federal codes for unfired pressure vessels.